

Index 2025

Nickel Titanium / *Nickel Titanium*

pag. A1 - A10

Acciaio / *Steel*

pag. B1 - B10

Estetica / *Aesthetics*

pag. C1 - C6

Attacchi Metallici / *Metal Brackets*

pag. D1 - D6

Bande e Tubi / *Bands and Tubes*

pag. E1 - E10

Impianti ortodontici / *Orthodontic implants*

pag. F1 - F5

Adesivi / *Bonding*

pag. G1 - G6

Elastomeri e Trazioni / *Elastomers and Traction*s

pag. H1 - H12

Accessori / *Accessories*

pag. I1 - I12

S&TCR

pag. J1 - J8

Laboratorio / *Laboratory*

pag. K1 - K16

Pinze e Strumenti / *Pliers and Instruments*

pag. L1 - L8

Attrezzatura / *Equipment*

pag. M1 - M4

Nickel Titanio / *Nickel Titanium*

Archi Ni-Ti / Ni-Ti archwires

Eclipse Archwires è il nuovo brand di qualità della linea Ortho World. Le proprietà elastiche e di memoria della lega Nickel Titanio garantiscono indeformabilità e superelasticità. La superficie, accuratamente rifinita, favorisce lo scorrimento del filo negli slot, riducendo notevolmente le resistenze da attrito.

Eclipse Archwires is the new brand of Ortho World line. Ni-Ti elastic and memory properties guarantee non-deformability and high elasticity. Its surface, carefully finished, allows wire sliding reducing friction resistance.



Over Ni-Ti Superelastic

	NATURALFORM	
	UPPER	LOWER
.012	NS012	NI012
.014	NS014	NI014
.016	NS016	NI016
.018	NS018	NI018
.020	NS020	NI020
.016x.016	NS1616	NI1616
.016x.022	NS1622	NI1622
.017x.025	NS1725	NI1725
.018x.025	NS1825	NI1825
.019x.025	NS1925	NI1925
.021x.025	NS2125	NI2125
10 pcs / pack		

Over Ni-Ti Superelastic

	EUROFORM	
	UPPER	LOWER
.012	ES012	EI012
.014	ES014	EI014
.016	ES016	EI016
.018	ES018	EI018
.020	ES020	EI020
.016x.016	ES1616	EI1616
.016x.022	ES1622	EI1622
.017x.025	ES1725	EI1725
.018x.025	ES1825	EI1825
.019x.025	ES1925	EI1925
.021x.025	ES2125	EI2125
10 pcs / pack		

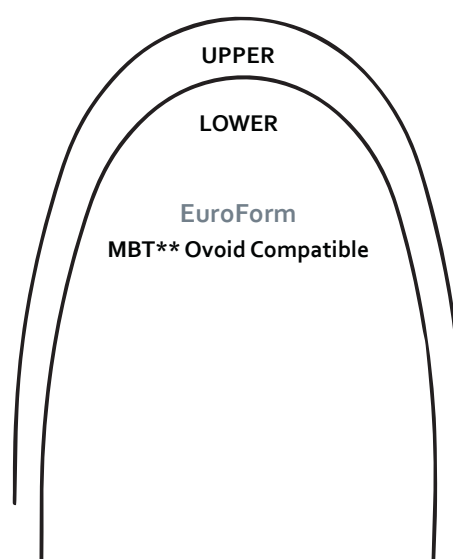
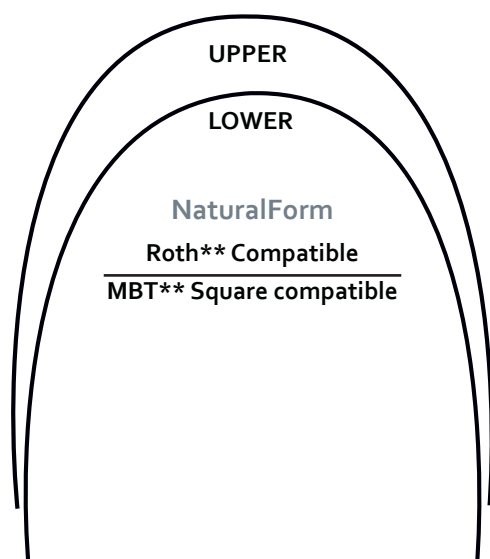

■ Merce disponibile / Goods available

■ Merce a richiesta / Goods on request

Ni-Ti Superelastic (Solo-Pack)

	NATURALFORM	
	UPPER	LOWER
.012	NSS012	NIS012
.014	NSS014	NIS014
.016	NSS016	NIS016
.018	NSS018	NIS018
.020	NSS020	NIS020
.016x.016	NSS1616	NIS1616
.016x.022	NSS1622	NIS1622
.017x.025	NSS1725	NIS1725
.018x.025	NSS1825	NIS1825
.019x.025	NSS1925	NIS1925
.021x.025	NSS2125	NIS2125
10 pcs / pack*		

* archi imbustati singolarmente / individually sealed archwires

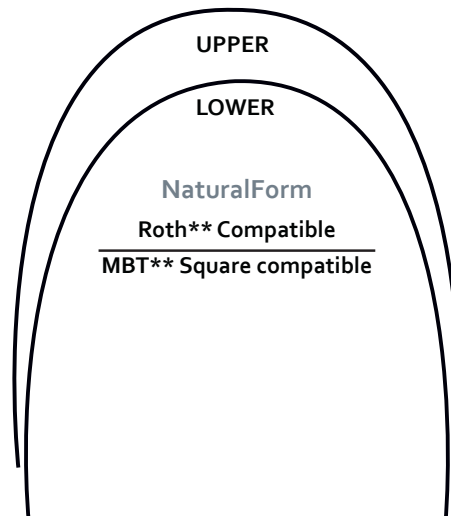

*(Solo-Pack)

Archi Termici Ni-Ti / Thermal Ni-Ti archwires

Gli archi ad attivazione termica possono essere piegati a temperatura ambiente, ma una volta introdotti nel cavo orale ($\pm 37^{\circ}\text{C}$), tornano ad assumere la forma iniziale.

They are thermal activated, can be bent at room temperature and, within the oral cavity (37°) they return to the original shape.

Ni-Ti Thermal (Solo-Pack)

	NATURALFORM	
	UPPER	LOWER
.012	TSS012	TIS012
.014	TSS014	TIS014
.016	TSS016	TIS016
.018	TSS018	TIS018
.020	TSS020	TIS020
.016x.016	TSS1616	TIS1616
.016x.022	TSS1622	TIS1622
.017x.025	TSS1725	TIS1725
.018x.025	TSS1825	TIS1825
.019x.025	TSS1925	TIS1925
.021x.025	TSS2125	TIS2125
10 pcs / pack*		

* archi imbustati singolarmente / individually sealed archwires

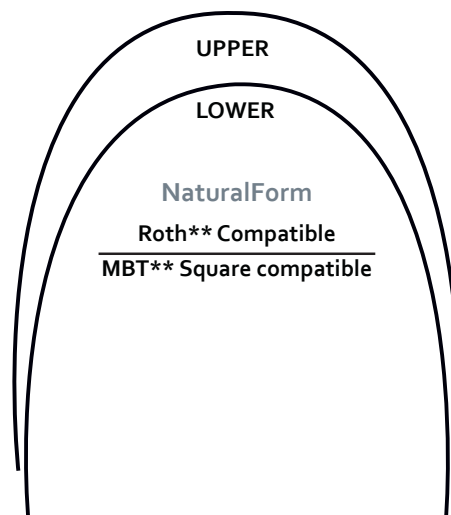

*(Solo-Pack)

- Merce disponibile / Goods available
- Merce a richiesta / Goods on request

Archi Cu-NiTi / Cu-NiTi archwires

Gli archi Cu-NiTi sono realizzati con una innovativa lega di Nickel, Titanio, Rame e una piccola quantità di Cromo. La particolarità consiste nell'aggiunta del rame che ottimizza le proprietà termiche e aumenta la resistenza alla deformazione del filo.

Gli archi in lega Cu-NiTi inoltre risultano avere le superfici ancora più lisce, al fine di massimizzare le caratteristiche di scorrimento negli slot.

Cu-NiTi wires are made with an innovative Ni-Ti, Copper and small quantity of Chromium alloy; the presence of copper enhances the thermal properties and the resistance to wire strains. Cu-NiTi wires have smoother surfaces to maximize the sliding characteristics.

Temperatura di attivazione 35°

Activating temperature 35°

Cu-NiTi composition material

Nikel = 48,8 %

Titanium= The remaining percentage

Copper= 5 %

Chromium= 0.5 % max



Cu-NiTi (Solo-Pack)

	NATURALFORM	
	UPPER	LOWER
.013	CNS013	CNI013
.014	CNS014	CNI014
.016	CNS016	CNI016
.018	CNS018	CNI018
.014x.025	CNS1425	CNI1425
.016x.025	CNS1625	CNI1625
.018x.025	CNS1825	CNI1825
10 pcs / pack*		

* archi imbustati singolarmente / individually sealed archwires

Cu-NiTi (Solo-Pack)

	EUROFORM	
	UPPER	LOWER
.013	CES013	CEI013
.014	CES014	CEI014
.016	CES016	CEI016
.018	CES018	CEI018
.014x.025	CES1425	CEI1425
.016x.025	CES1625	CEI1625
.018x.025	CES1825	CEI1825
10 pcs / pack*		

* archi imbustati singolarmente / individually sealed archwires

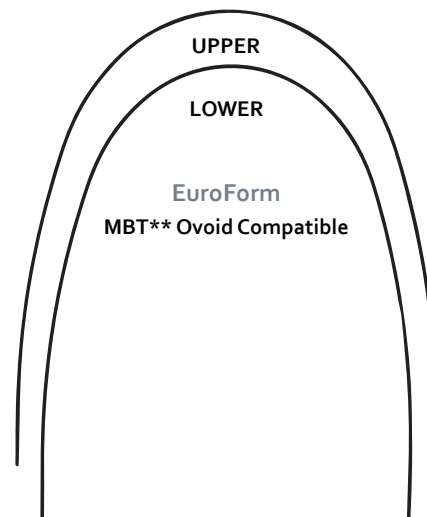
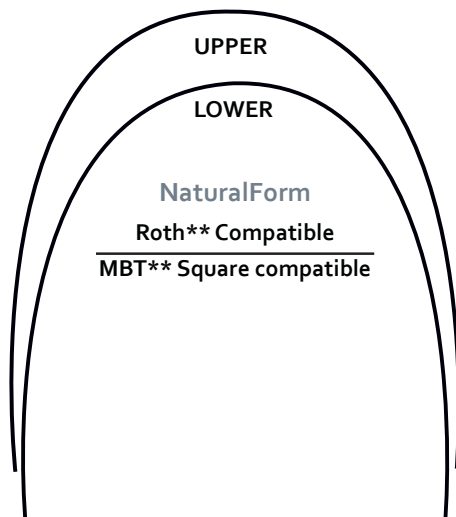

*(Solo-Pack)

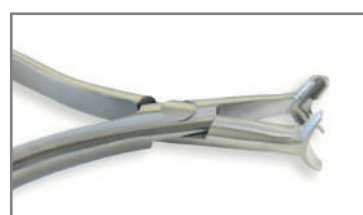

PL-330

Pinza per formare angoli retti su fili in nickel titanio e acciaio Ø max .028"

Plier for right angles

(Ni-Ti and steel wires) Ø max .028"

■ Merce disponibile / Goods available

■ Merce a richiesta / Goods on request

Archi Ni-Ti superelastici / Ni-Ti superelastic archwires

La caratteristica distintiva della lega di Nickel Titanio rappresentata dalla sua particolare memoria elastica ne consente di effettuare pieghe sullo stesso filo. Questa caratteristica risulta particolarmente facilitata sui fili a sezione tonda mentre quelli a sezione quadrata e rettangolare risultano più rigidi. La linea mediana è contrassegnata con tre tacche sui superiori e una sugli inferiori.

Nickel-Titanium alloy quality is realized with an elastic memory property, in order to bend archwires. This characteristics is simplified on round section wires; square and rectangular wires are more rigid. Midline is marked with three lines for upper arches and one for lower ones.

Ni-Ti superelastic archwires

	TRUEARCH I		EUROARCH I		EUROARCH II	
	UPPER	LOWER	UPPER	LOWER	UPPER	LOWER
.012	SETFU012	SETFL012	SEEFU012	SEEFL012	SEEFU112	SEEFL112
.013	-	-	-	-	SEEFU113	SEEFL113
.014	SETFU014	SETFL014	SEEFU014	SEEFL014	SEEFU114	SEEFL114
.016	SETFU016	SETFL016	SEEFU016	SEEFL016	SEEFU116	SEEFL116
.018	SETFU018	SETFL018	SEEFU018	SEEFL018	SEEFU118	SEEFL118
.020	SETFU020	SETFL020	SEEFU020	SEEFL020	SEEFU120	SEEFL120
.014x.025	-	-	SEEFU1425	SEEFL1425	SEEFU3425	SEEFL3425
.016x.016	SETFU1616	SETFL1616	SEEFU1616	SEEFL1616	SEEFU3616	SEEFL3616
.016x.022	SETFU1622	SETFL1622	SEEFU1622	SEEFL1622	SEEFU3622	SEEFL3622
.016x.025	-	-	SEEFU1625	SEEFL1625	SEEFU3625	SEEFL3625
.017x.025	SETFU1725	SETFL1725	SEEFU1725	SEEFL1725	SEEFU3725	SEEFL3725
.018x.018	SETFU1818	SETFL1818	SEEFU1818	SEEFL1818	SEEFU3818	SEEFL3818
.018x.025	SETFU1825	SETFL1825	SEEFU1825	SEEFL1825	SEEFU3825	SEEFL3825
.019x.025	SETFU1925	SETFL1925	SEEFU1925	SEEFL1925	SEEFU3925	SEEFL3925
.020x.020	SETFU2020	SETFL2020	SEEFU2020	SEEFL2020	SEEFU3020	SEEFL3020
.021x.025	SETFU2125	SETFL2125	SEEFU2125	SEEFL2125	SEEFU3125	SEEFL3125

10 pcs / pack

Damon compatible*

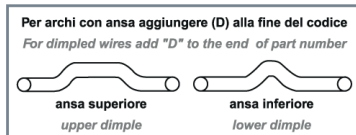
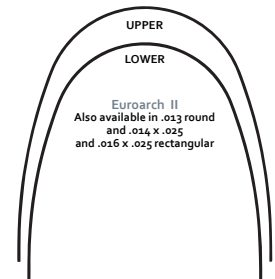
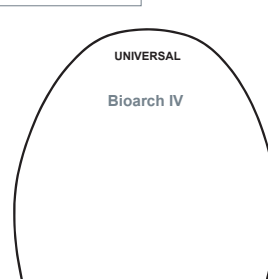
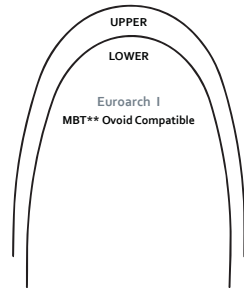
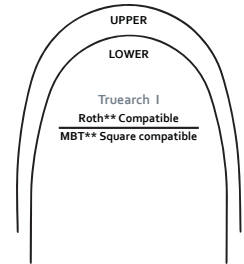

Ni-Ti superelastic archwires

	STANDARD		BIOARCH III		BIOARCH IV
	UPPER	LOWER	UPPER	LOWER	UNIVERSAL
.012	SESFU012	SESFL012	SEBF3U012	SEBF3L012	G4BF412
.014	SESFU014	SESFL014	SEBF3U014	SEBF3L014	G4BF414
.016	SESFU016	SESFL016	SEBF3U016	SEBF3L016	G4BF416
.018	SESFU018	SESFL018	SEBF3U018	SEBF3L018	G4BF418
.020	SESFU020	SESFL020	SEBF3U020	SEBF3L020	G4BF420
.016x.016	SESFU1616	SESFL1616	SEBF3U1616	SEBF3L1616	G4BF41616
.016x.022	SESFU1622	SESFL1622	SEBF3U1622	SEBF3L1622	G4BF41622
.017x.025	SESFU1725	SESFL1725	SEBF3U1725	SEBF3L1725	G4BF41725
.018x.018	SESFU1818	SESFL1818	SEBF3U1818	SEBF3L1818	G4BF41818
.018x.025	SESFU1825	SESFL1825	SEBF3U1825	SEBF3L1825	G4BF41825
.019x.025	SESFU1925	SESFL1925	SEBF3U1925	SEBF3L1925	G4BF41925
.020x.020	SESFU2020	SESFL2020	SEBF3U2020	SEBF3L2020	G4BF42020
.021x.025	SESFU2125	SESFL2125	SEBF3U2125	SEBF3L2125	G4BF42125

10 pcs / pack

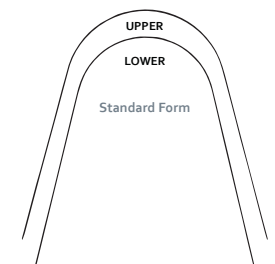
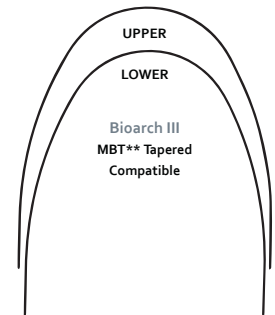

■ Merce disponibile / Goods available
 ■ Merce a richiesta / Goods on request

* Damon è un marchio registrato della Ormco Corporation / Damon is a trademark by Ormco Corporation
 * MBT è un marchio registrato della 3M Unitek / MBT is a trademark of 3M Unitek

Archi Termici Ni-Ti / Thermal Ni-Ti archwires

Gli archi in Nickel Titanio termici consentono una distribuzione di forze basse e costanti nel tempo. Possono essere piegati a temperatura ambiente, ma una volta introdotti nel cavo orale (+ 37°C), tornano ad assumere la loro forma iniziale.

Thermal Ni-Ti archwires allow distributing low and constant forces. They are thermal activated and can be bent at room temperature; within the oral cavity (37°) they return to their original shape.



Thermal Ni-Ti archwires

Damon compatible*

	TRUEARCH I		EUROARCH I		EUROARCH II	
	UPPER	LOWER	UPPER	LOWER	UPPER	LOWER
.012	TTFU012	TTFL012	TEFU012	TEFL012	TEFU112	TEFL112
.014	TTFU014	TTFL014	TEFU014	TEFL014	TEFU114	TEFL114
.016	TTFU016	TTFL016	TEFU016	TEFL016	TEFU116	TEFL116
.018	TTFU018	TTFL018	TEFU018	TEFL018	TEFU118	TEFL118
.020	TTFU020	TTFL020	TEFU020	TEFL020	TEFU120	TEFL120
.014x.025	-	-	-	-	TEFU3425	TEFL3425
.016x.016	TTFU1616	TTFL1616	TEFU1616	TEFL1616	TEFU3616	TEFL3616
.016x.022	TTFU1622	TTFL1622	TEFU1622	TEFL1622	TEFU3622	TEFL3622
.016x.025	-	-	-	-	TEFU3625	TEFL3625
.017x.025	TTFU1725	TTFL1725	TEFU1725	TEFL1725	TEFU3725	TEFL3725
.018x.018	TTFU1818	TTFL1818	TEFU1818	TEFL1818	TEFU3818	TEFL3818
.018x.025	TTFU1825	TTFL1825	TEFU1825	TEFL1825	TEFU3825	TEFL3825
.019x.025	TTFU1925	TTFL1925	TEFU1925	TEFL1925	TEFU3925	TEFL3925
.020x.020	TTFU2020	TTFL2020	TEFU2020	TEFL2020	TEFU3020	TEFL3020
.021x.025	TTFU2125	TTFL2125	TEFU2125	TEFL2125	TEFU3125	TEFL3125

10 pcs / pack

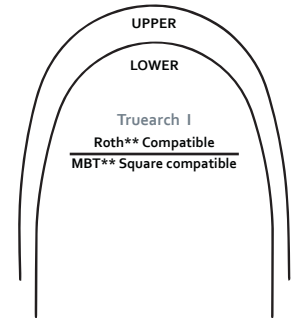

Per archi con ansa aggiungere (D) alla fine del codice
For dimpled wires add "D" to the end of part number

Thermal Ni-Ti archwires

	STANDARD		BIOARCH III	
	UPPER	LOWER	UPPER	LOWER
.012	TSFU012	TSFL012	TBF3U012	TBF3L012
.014	TSFU014	TSFL014	TBF3U014	TBF3L014
.016	TSFU016	TSFL016	TBF3U016	TBF3L016
.018	TSFU018	TSFL018	TBF3U018	TBF3L018
.020	TSFU020	TSFL020	TBF3U020	TBF3L020
.016x.016	TSFU1616	TSFL1616	TBF3U1616	TBF3L1616
.016x.022	TSFU1622	TSFL1622	TBF3U1622	TBF3L1622
.017x.025	TSFU1725	TSFL1725	TBF3U1725	TBF3L1725
.018x.018	TSFU1818	TSFL1818	TBF3U1818	TBF3L1818
.018x.025	TSFU1825	TSFL1825	TBF3U1825	TBF3L1825
.019x.025	TSFU1925	TSFL1925	TBF3U1925	TBF3L1925
.020x.020	TSFU2020	TSFL2020	TBF3U2020	TBF3L2020
.021x.025	TSFU2125	TSFL2125	TBF3U2125	TBF3L2125

10 pcs / pack

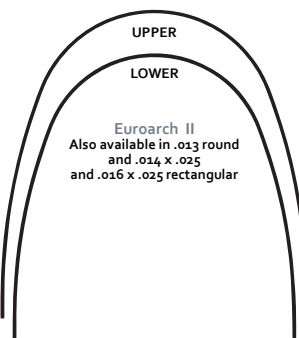
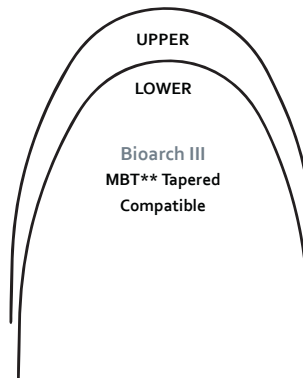
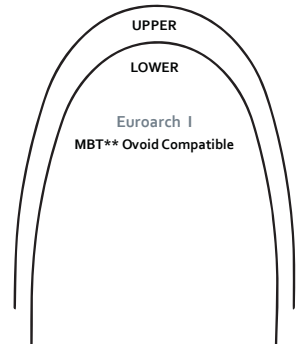
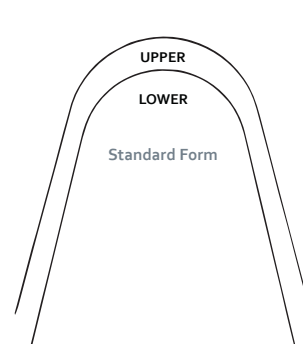

* Damon è un marchio registrato della Ormco Corporation
Damon is a trademark by Ormco Corporation

■ Merce disponibile / Goods available
■ Merce a richiesta / Goods on request

Archi curva inversa Ni-Ti / Reverse curve Ni-Ti

Realizzati in Nickel Titanio superelastico o termico, sviluppano eccellenti forze atte a realizzare rapidamente ed efficientemente modifiche del morso.

They are manufactured in both superelastic and thermal Ni-Ti, they provide excellent forces to achieve bite modifications quickly and efficiently.

Reverse Curve I

	SUPERELASTIC Ni-Ti		THERMAL Ni-Ti	
	UPPER	LOWER	UPPER	LOWER
.012	SERCU012	SERCL012	TRCU012	TRCL012
.014	SERCU014	SERCL014	TRCU014	TRCL014
.016	SERCU016	SERCL016	TRCU016	TRCL016
.018	SERCU018	SERCL018	TRCU018	TRCL018
.020	SERCU020	SERCL020	TRCU020	TRCL020
.016x.016	SERCU1616	SERCL1616	TRCU1616	TRCL1616
.016x.022	SERCU1622	SERCL1622	TRCU1622	TRCL1622
.017x.025	SERCU1725	SERCL1725	TRCU1725	TRCL1725
.018x.018	SERCU1818	SERCL1818	TRCU1818	TRCL1818
.018x.025	SERCU1825	SERCL1825	TRCU1825	TRCL1825
.019x.025	SERCU1925	SERCL1925	TRCU1925	TRCL1925
.020x.020	SERCU2020	SERCL2020	TRCU2020	TRCL2020
.021x.025	SERCU2125	SERCL2125	TRCU2125	TRCL2125
10 pcs / pack				

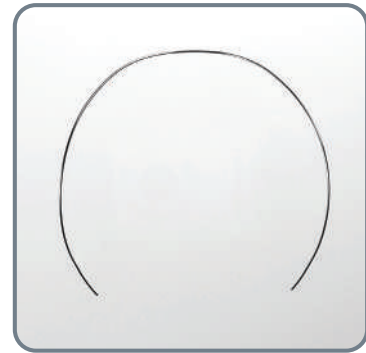

Esclusiva con moderata curva torque e distal toe-in.
Original with moderate curve torque and distal toe-in.

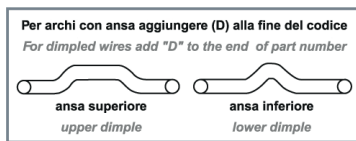

Fili dritti e spolette Ni-Ti / Ni-Ti spools and straight wires

Fili dritti e spolette in Nickel Titanio superelastico per archi e applicazioni settoriali. Disponibili in fili dritti da 7" e spolette da 15ft.

Straight wires and spools in superelastic Ni-Ti for archwires and sectorial applications. Available in 7" lengths and 15ft spools.

Spoletta e filo dritto / Spool and straight wire

	ROUND	SPOLED
.010	SENT010	SESP010
.012	SENT012	SESP012
.014	SENT014	SESP014
.016	SENT016	SESP016
.018	SENT018	SESP018
.020	SENT020	SESP020
10 pcs / pack		

Filo dritto / Straight wire

	RECTANGULAR
.014x.025	SENT1425
.016x.016	SENT1616
.016x.022	SENT1622
.017x.025	SENT1725
.018x.018	SENT1818
.018x.025	SENT1825
.019x.025	SENT1925
.020x.020	SENT2020
.021x.025	SENT2125
10 pcs / pack	

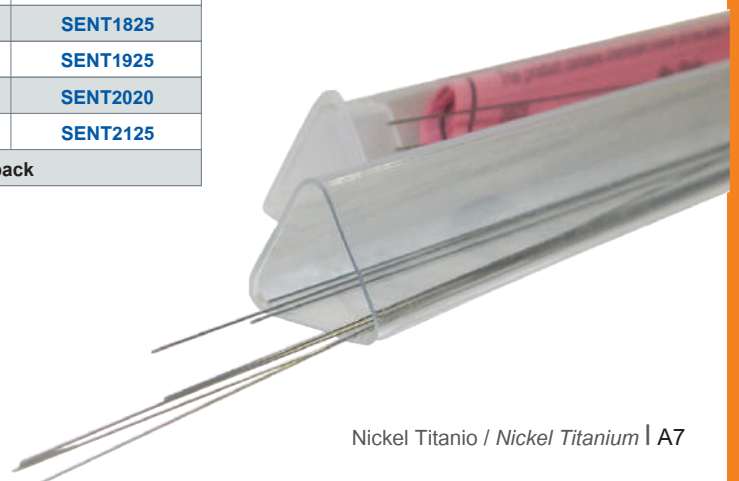

Archi linguali Universali / Universal lingual archwires

S304 Stainless Steel Lingual Archwires

	UNIVERSAL
.014	S3L014
.016	S3L016
.018	S3L018
.016x.022	S3L1622
5 pcs / pack	



Ni-Ti Universal Lingual Archwires

	UNIVERSAL					
	.010	.012	.014	.016	.016x.022	.017x.017
SMALL	G4SLUN010	G4SLUN012	G4SLUN014	G4SLUN016	-	-
MEDIUM	G4MLUN010	G4MLUN012	G4MLUN014	G4MLUN016	-	-
LARGE	G4LLUN010	G4LLUN012	G4LLUN014	G4LLUN016	-	-
EXTRA LARGE	G4XLUN010	G4XLUN012	G4XLUN014	G4XLUN016	G4XLUN1622	G4XLUN1717
5 pcs / pack						

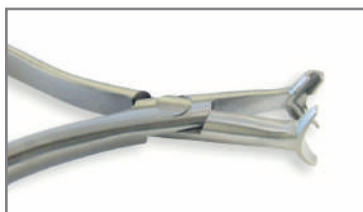
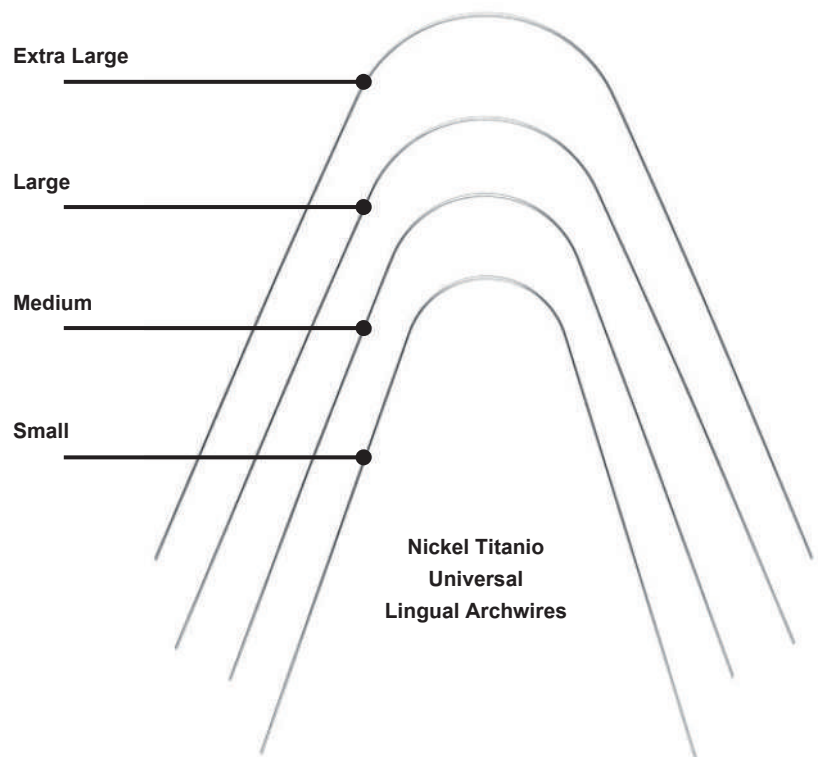
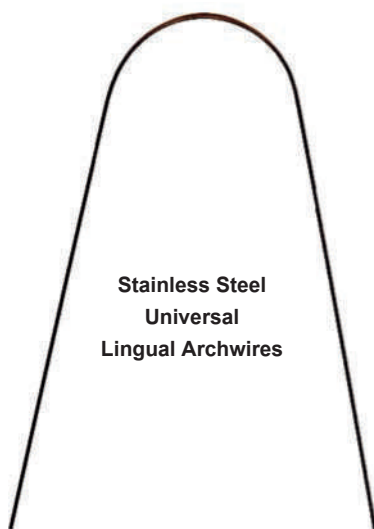

PL-330

Pinza per formare angoli retti su fili in nickel titanio e acciaio Ø max .028"

Plier for right angles

(Ni-Ti and steel wires) Ø max .028"

■ Merce disponibile / Goods available

■ Merce a richiesta / Goods on request

Molle Ni-Ti aperte / Ni-Ti open coil springs

La particolarità di queste molle è l'altissima memoria attiva, data dalle caratteristiche del materiale di cui sono composte.

Il Nickel Titanio consente una attivazione automatica e progressiva che permette di evitare frequenti sostituzioni come le molle in acciaio. Sono disponibili in confezioni da 7" in tubi o in spolette da 21".

The main feature of these springs is their high active memory created by those characteristics of the material they are composed of. Ni-Ti enables an automatic progressive activation and avoids frequent replacements of springs as the steel traditional ones. Available in tubes of 7" and 21" spoils.



Ni-Ti open coil springs

Ø WIRE	SPRING	FORCE	7" DRITTO / STRAIGHT	21" SPOLETTA / SPOOL
.009"	.030	Ex-Light	OCNT09307	OCNT093021
.010"	.030	Light	OCNT10307	OCNT103021
.010"	.036	Medium-Light	OCNT10367	OCNT103621
.012"	.030	Medium	OCNT12307	OCNT123021
.012"	.036	Medium-Heavy	OCNT12367	OCNT123621
.014"	.030	Heavy	OCNT14307	OCNT143021
.014"	.036	Extra-Heavy	OCNT14367	OCNT143621
.010"	.045	Facebow/lip	OCNT10457	OCNT104521

3 pcs / pack for straight lengths

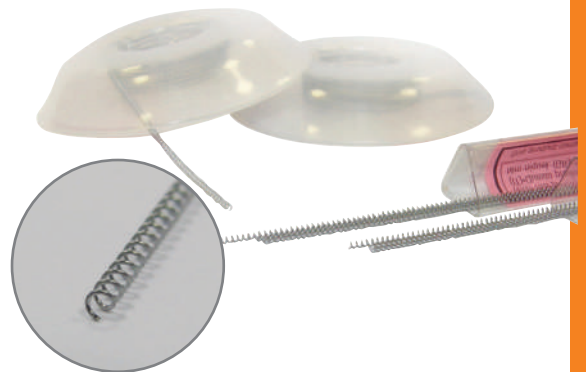

Molle Ni-Ti aperte / Ni-Ti open coil springs

Le molle aperte in Nickel Titanio superelastico aprono spazi fino a 15mm. Possono essere compresse fino a 3 mm, rilasciando una forza continua e leggera.

Super-elastic Ni-Ti open coil springs are designed for opening spaces up to 15 mm. They are pressed up to 3 mm realising continuous and light force.

Ni-Ti open coil springs

SPRING	FORCE	15 mm
.036	100gr. Light	OCNT15100
.036	150gr. Medium	OCNT15150
.036	200 gr. Heavy	OCNT15200

10 pcs / pack

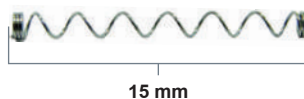

Molle Ni-Ti aperte per distalizzare / Distalizing open coil springs

Dotate di forze leggere da 100 grammi per distalizzare in media 1mm / 1,5mm al mese, sono indicate per dispositivi di distalizzazione.

Open coil springs deliver gentle 100 grams of force to achieve average 1 mm to 1,5 mm distalization per month. They are recommended to distalizing devices.

Distalizing open coil springs

7" Dritto / Straight	OCNT7045
21" Spoletta / Spool	OCNT2145

3 pcs / pack

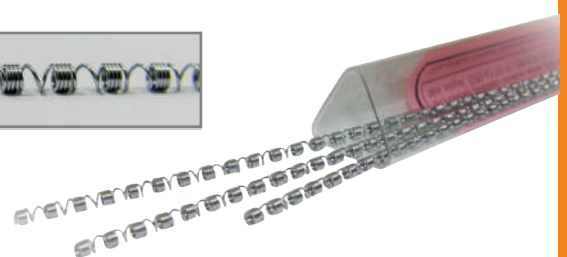

- Merce disponibile / Goods available
- Merce a richiesta / Goods on request

Molle Ni-Ti chiuse / Ni-Ti closed coil springs

Le molle chiuse in Nickel Titanio, in spoletta da 21" con diametro .030, esprimono forze che variano dai 100 g ai 250 g.
Ni-Ti closed coil springs in spool of 21" with .030 diameter deliver forces from 100 grams to 250 grams.

Ni-Ti closed coil springs

SPRING	FORCE	21" SPOLETTA / SPOOL
.030	100gr. Ultra Light	CCNT21075
.030	150gr. Light	CCNT21150
.030	200gr. Medium	CCNT21200
.030	250gr. Heavy	CCNT21250
Spool		

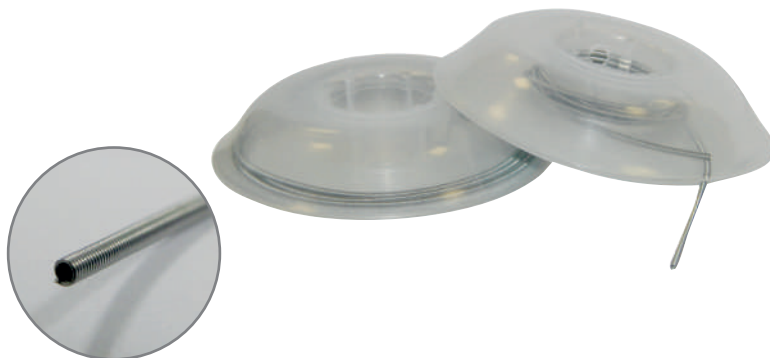



Molle Ni-Ti chiuse / Ni-Ti closed coil springs

Le molle chiuse in Nickel Titanio esprimono forze fino a 250 gr. ed hanno una estensione fino a 12 mm. Possono essere applicate ai ganci degli attacchi, dei tubi, e vengono utilizzati abitualmente per chiudere gli spazi.

Ni-Ti closed springs deliver forces up to 250 grams, with extension up to 12 mm. They can be applied to brackets or tube hooks and are usually used to close spaces.

Forza di estensione / Extension force

LENGHT (passive spring length)	SIZE	FORCE (force rating)	ORDER NUMBERS (10 springs/box)	11mm	14mm	17mm	21mm	28mm	36mm
 9mm	9F	50gr. Feather Light	CS0809	30	35	40	50*	-	-
	9X	100gr. Extra Light	CS1009	60	70	80	100*	-	-
	9L	150gr. Light	CS10509	95	115	130	150*	-	-
	9M	200gr. Medium	CS1109	120	145	165	200*	-	-
	9H	250gr. Heavy	CS1209	135	175	210	250*	-	-
 12mm	12F	50gr. Feather Light	CS0812	-	30	32	35	40	50*
	12X	100gr. Extra Light	CS1012	-	60	65	70	80	100*
	12L	150gr. Light	CS10512	-	95	100	115	130	150*
	12M	200gr. Medium	CS1112	-	120	130	145	165	200*
	12H	250gr. Heavy	CS1212	-	135	150	175	210	250*
10 pcs / pack									

* indica il valore massimo di estensione rispetto alla lunghezza della molla. In caso di estensione superiore al valore indicato, la molla potrebbe subire deformazioni
It indicates the maximum overall extension for the respective spring length. Extending springs beyond the suggested maximum value can cause permanent deformation and distort applied force values.

Misuratore:

Il righello mostra su un lato, evidenziati a colori, i punti di riferimento dell'estensione delle molle e dall'altro identifica, con diversi colori corrispondenti i pesi delle molle.

Measuring Gauge:

Unique CC ruler features holes to engage a hook simulating a spring eyelet. Measurements from one hook to the opposing hook are exact. Dual sided ruler displays landmark extensions highlighted in red on one side and the corresponding 150 g spring referenced by color coded ID on the other.

Ruler	CCOFMG
20 pcs / pack	

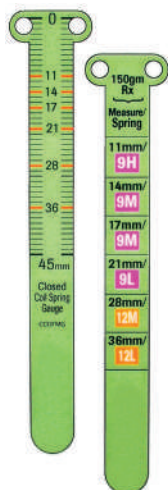

■ Merce disponibile / Goods available

■ Merce a richiesta / Goods on request

Acciaio / Steel

Archi e fili in acciaio / Stainless Steel archwires and wires

Gli archi e i fili in acciaio sono realizzati esclusivamente con acciaio di grado 304v ad uso medicale. Grazie all'utilizzo di macchinari di ultimissima generazione, gli archi e i fili in acciaio assicurano precisione e costanza nei risultati.

Stainless Steel archwires and wires are only made with 304v grade stainless steel for medical use. Thanks to last generation equipment, Stainless Steel archwires and wires ensure precise and constant results.



Stainless Steel archwires

Damon compatible*

	TRUEARCH I		EUROARCH I		EUROARCH II		STANDARD	
	UPPER	LOWER	UPPER	LOWER	UPPER	LOWER	UPPER	LOWER
.012	SSTFU012	SSTFL012	SSEFU012	SSEFL012	SSEFU112	SSEFL112	SSSFU012	SSSFL012
.014	SSTFU014	SSTFL014	SSEFU014	SSEFL014	SSEFU114	SSEFL114	SSSFU014	SSSFL014
.016	SSTFU016	SSTFL016	SSEFU016	SSEFL016	SSEFU116	SSEFL116	SSSFU016	SSSFL016
.018	SSTFU018	SSTFL018	SSEFU018	SSEFL018	SSEFU118	SSEFL118	SSSFU018	SSSFL018
.020	SSTFU020	SSTFL020	SSEFU020	SSEFL020	SSEFU120	SSEFL120	SSSFU020	SSSFL020
.016x.016	SSTFU1616	SSTFL1616	SSEFU1616	SSEFL1616	SSEFU3616	SSEFL3616	SSSFU1616	SSSFL1616
.016x.022	SSTFU1622	SSTFL1622	SSEFU1622	SSEFL1622	SSEFU3622	SSEFL3622	SSSFU1622	SSSFL1622
.016x.025	-	-	SSEFU1625	SSEFL1625	SSEFU3625	SSEFL3625	-	-
.017x.017	SSTFU1717	SSTFL1717	SSEFU1717	SSEFL1717	SSEFU3717	SSEFL3717	SSSFU1717	SSSFL1717
.017x.022	SSTFU1722	SSTFL1722	SSEFU1722	SSEFL1722	SSEFU3722	SSEFL3722	SSSFU1722	SSSFL1722
.017x.025	SSTFU1725	SSTFL1725	SSEFU1725	SSEFL1725	SSEFU3725	SSEFL3725	SSSFU1725	SSSFL1725
.018x.018	SSTFU1818	SSTFL1818	SSEFU1818	SSEFL1818	SSEFU3818	SSEFL3818	SSSFU1818	SSSFL1818
.018x.022	SSTFU1822	SSTFL1822	SSEFU1822	SSEFL1822	SSEFU3822	SSEFL3822	SSSFU1822	SSSFL1822
.018x.025	SSTFU1825	SSTFL1825	SSEFU1825	SSEFL1825	SSEFU3825	SSEFL3825	SSSFU1825	SSSFL1825
.019x.019	SSTFU1919	SSTFL1919	SSEFU1919	SSEFL1919	SSEFU3919	SSEFL3919	SSSFU1919	SSSFL1919
.019x.025	SSTFU1925	SSTFL1925	SSEFU1925	SSEFL1925	SSEFU3925	SSEFL3925	SSSFU1925	SSSFL1925
.020x.020	SSTFU2020	SSTFL2020	SSEFU2020	SSEFL2020	SSEFU3020	SSEFL3020	SSSFU2020	SSSFL2020
.021x.025	SSTFU2125	SSTFL2125	SSEFU2125	SSEFL2125	SSEFU3125	SSEFL3125	SSSFU2125	SSSFL2125

25 pcs / pack

14" Filo Dritto / Straight wires

ROUND		RECTANGULAR	
.012	STSS012	.016x.016	STSS1616
.014	STSS014	.016x.022	STSS1622
.016	STSS016	.017x.017	STSS1717
.018	STSS018	.017x.025	STSS1725
.020	STSS020	.018x.018	STSS1818
.022	STSS022	.018x.022	STSS1822
.024	STSS024	.018x.025	STSS1825
.026	STSS026	.019x.019	STSS1919
.028	STSS028	.019x.025	STSS1925
.030	STSS030	.020x.020	STSS2020
.032	STSS032	.021x.025	STSS2125
.036	STSS036	25 pcs / pack	
.040	STSS040	25 pcs / pack	
.045	STSS045	25 pcs / pack	
.051	STSS051	25 pcs / pack	

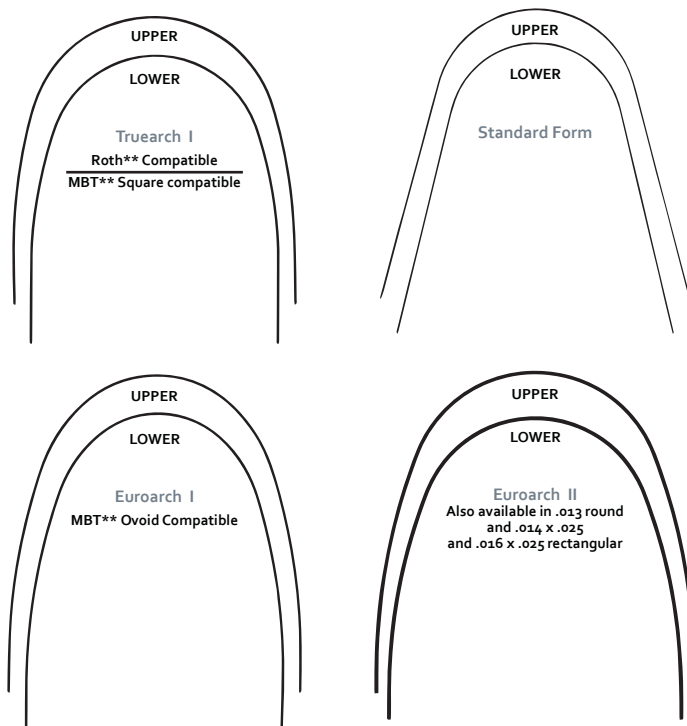

* Damon è un marchio registrato della Ormco Corporation / Damon is a trademark by Ormco Corporation

** MBT è un marchio registrato della 3M Unitek / MBT is a trademark of 3M Unitek

■ Merce disponibile / Goods available

■ Merce a richiesta / Goods on request

Archi in Acciaio / Stainless Steel archwires

Stainless Steel archwires



	NATURALFORM	
	UPPER	LOWER
.012	ASS012	AIS012
.014	ASS014	AIS014
.016	ASS016	AIS016
.018	ASS018	AIS018
.020	ASS020	AIS020
.016x.016	ASS1616	AIS1616
.016x.022	ASS1622	AIS1622
.017x.022	ASS1722	AIS1722
.017x.025	ASS1725	AIS1725
.018x.025	ASS1825	AIS1825
.019x.025	ASS1925	AIS1925
.021x.025	ASS2125	AIS2125
10 pcs / pack		

	EUROFORM	
	UPPER	LOWER
.012	ASE012	AIE012
.014	ASE014	AIE014
.016	ASE016	AIE016
.018	ASE018	AIE018
.020	ASE020	AIE020
.016x.016	ASE1616	AIE1616
.016x.022	ASE1622	AIE1622
.017x.022	ASE1722	AIE1722
.017x.025	ASE1725	AIE1725
.018x.025	ASE1825	AIE1825
.019x.025	ASE1925	AIE1925
.021x.025	ASE2125	AIE2125
10 pcs / pack		

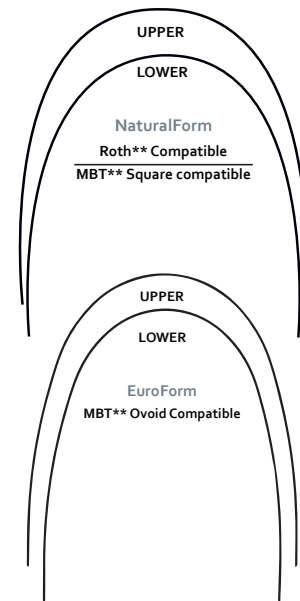

A.J. Wilcock® filo australiano / A.J. Wilcock® Australian wire



	STRAIGHT	ROLLED
.014	AW051-401	AW051-402
.016	AW051-601	AW051-602
.018	AW051-801	AW051-802
10 pcs / pack		Spool

	REGULAR	REGULAR+	SPECIAL	SPECIAL+	PREMIUM	PREMIUM+	SUPREME
	Pink	Green	Blue	Yellow	Purple	Gold	Beige
.009	-	-	-	-	-	-	AW227-060
.010	-	-	-	-	-	AW228-050	AW228-060
.011	-	-	-	-	-	AW228-150	AW228-160
.012	AW229-000	AW229-010	AW229-020	AW229-030	AW229-040	AW229-050	-
.014	AW230-100	AW230-110	AW230-120	AW230-130	AW230-140	AW230-150	-
.016	AW231-300	AW231-310	AW231-320	AW231-330	AW231-340	AW231-350	-
.018	AW232-400	AW232-410	AW232-420	AW232-430	AW232-440	AW232-450	-
.020	AW233-500	AW233-510	AW233-520	AW233-530	AW233-540	-	-
.022	AW234-600	-	-	AW234-630	-	-	-
.024	AW235-700	-	AW235-720	AW235-730	-	-	-
Spool							



- Merce disponibile / Goods available
- Merce a richiesta / Goods on request

Archi e fili in acciaio intrecciati / Multi-strand stainless steel archwires

I fili intrecciati in acciaio offrono una maggiore flessibilità e resistenza alla rottura rispetto al filo singolo, grazie ad una accurata finitura saldamente avvolta, garantisce anche un ottimo scorrimento, garantendo una forza elastica nel tempo. Evita gli effetti traumatici per il paziente nelle prime fasi del trattamento. Non si staccano nei punti di taglio.

Multi-strand stainless steel archwires give higher flexibility and resistance to breakage than the single wire, thanks to an external texture firmly wrapped that allows an excellent sliding. Multi-strand wires keep elastic force without traumatic effects in early treatments. Moreover, they don't detach in the cutting points.



Tre strati / Three Strands

	TRUEARCH I		STANDARD	
	UPPER	LOWER	UPPER	LOWER
.0155	-	-	-	-
.0175	-	-	-	-
.0195	-	-	-	-
.0215	-	-	-	-
.016x.016	CTFU1616	CTFL1616	CSFU1616	CSFL1616
.016x.022	CTFU1622	CTFL1622	CSFU1622	CSFL1622
.017x.025	CTFU1725	CTFL1725	CSFU1725	CSFL1725
.018x.025	CTFU1825	CTFL1825	CSFU1825	CSFL1825
.019x.025	CTFU1925	CTFL1925	CSFU1925	CSFL1925
25 pcs / pack				

DRITTO / STRAIGHT 14"
MS3155
MS3175
MS3195
MS3215
MS3616
MS3622
MS3725
MS3825
MS3925
25 pcs / pack

SPOLETTA / SPOOL 30"
SST3155
SST3175
SST3195
SST3215
-
-
-
-
-
Spools

Sei strati / Six Strands

	DRITTO / STRAIGHT 14"	SPOLETTA / SPOOL 30"
	.0155	MS6155
.0175	MS6175	SST6175
.0195	MS6195	SST6195
.0215	MS6215	SST6215
25 pcs / pack		Spools



Disponibile su richiesta *Three Strands*

Sette strati / Seven Strands

	DRITTO / STRAIGHT 14"	SPOLETTA / SPOOL 30"
	.0155	MS7155
.0175	MS7175	SST7175
.0195	MS7195	SST7195
.0215	MS7215	SST7215
25 pcs / pack		Spools



Disponibile su richiesta *Six Strands*

Otto strati / Eight Strands

	TRUEARCH I		STANDARD	
	UPPER	LOWER	UPPER	LOWER
.016x.016	CTFU8616	CTFL8616	CSFU8616	CSFL8616
.016x.022	CTFU8622	CTFL8622	CSFU8622	CSFL8622
.017x.025	CTFU8725	CTFL8725	CSFU8725	CSFL8725
.018x.025	CTFU8825	CTFL8825	CSFU8825	CSFL8825
.019x.025	CTFU8925	CTFL8925	CSFU8925	CSFL8925
.021x.025	CTFU8125	CTFL8125	CSFU8125	CSFL8125
25 pcs / pack				



Disponibile su richiesta *Eight Strands*

■ Merce disponibile / Goods available

■ Merce a richiesta / Goods on request

Orthology archi e fili blu / Blue Orthology wires and archwires

La lega Orthology, a base di cromo cobalto come l'Elgiloy®, ha eccezionali caratteristiche di malleabilità e resilienza. Disponibile in archi preformati o in fili dritti. È consigliato per la tecnica Ricketts.

Chromium-cobalt base Orthology, like Elgiloy®, is a very resilient and malleable alloy. Available in preformed archwires or straight wires; it is recommended for the Ricketts technique.

Archwires

	TRUEARCH I	
	UPPER	LOWER
.014	CBTFU014	CBTFL014
.016	CBTFU016	CBTFL016
.018	CBTFU018	CBTFL018
.016x.016	CBTFU1616	CBTFL1616
.016x.022	CBTFU1622	CBTFL1622
.017x.022	CBTFU1722	CBTFL1722
.017x.025	CBTFU1725	CBTFL1725
.018x.025	CBTFU1825	CBTFL1825
.019x.025	CBTFU1925	CBTFL1925
.021x.025	CBTFU2125	CBTFL2125

25 pcs / pack

DRITTO / STRAIGHT 14"	
.014	STRCB014
.016	STRCB016
.018	STRCB018
.028	STRCB028
.030	STRCB030
.032	STRCB032
.036	STRCB036
.040	STRCB040
.045	STRCB045
.051	STRCB051
.016x.016	STRCB1616
.016x.022	STRCB1622
.017x.025	STRCB1725
.018x.025	STRCB1825
.019x.025	STRCB1925
.021x.025	STRCB2125

25 pcs / pack

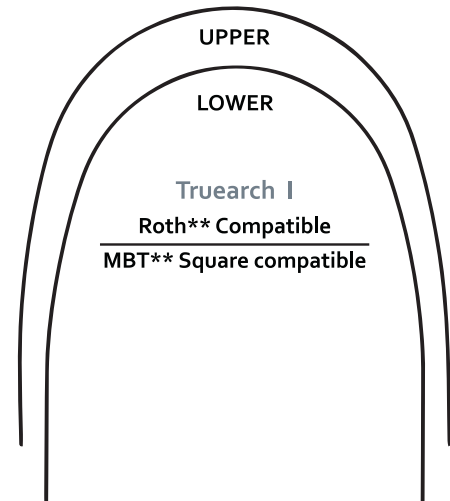

* Elgiloy Ricketts e Bioprogressiva sono marchi registrati della Rocky Mountain Orthodontics
 * Elgiloy Ricketts and Bioprogressiva are trademarks of Rocky Mountain Orthodontics

Biotitan archi e fili / Biotitan archwires and wires

Il BioTitan è un prodotto simile al TMA®, dalle identiche caratteristiche. I fili e gli archi in BioTitan hanno caratteristiche di adattabilità e maneggevolezza tipiche dell'acciaio con memoria di forma. Con la sua forza moderata, un ampio range di azione ed una eccellente duttilità, il filo in Beta Titanio può essere usato facilmente durante tutte le fasi del trattamento e specialmente in tutti i pazienti allergici al Nickel.

TMA® assayer admire the equivalent product BioTitan. Arches and wires have the same adaptability characteristics of steel and shape memory. Thanks to its moderate force, a wide range of actions and excellent ductility, Beta Titanium wire can be easily used during all treatment phases, especially to patients who are allergic to Ni-Ti.

Archwires

	TRUEARCH I		EUROARCH II	
	UPPER	LOWER	UPPER	LOWER
.016	TMTFU016	TMTFL016	-	-
.018	TMTFU018	TMTFL018	-	-
.016x.016	TMTFU1616	TMTFL1616	-	-
.016x.022	TMTFU1622	TMTFL1622	TMEFU3622	TMEFL3622
.017x.025	TMTFU1725	TMTFL1725	TMEFU3725	TMEFL3725
.018x.018	TMTFU1818	TMTFL1818	-	-
.018x.025	TMTFU1825	TMTFL1825	-	-
.019x.025	TMTFU1925	TMTFL1925	TMEFU3925	TMEFL3925
.020x.020	TMTFU2020	TMTFL2020	-	-
.021x.025	TMTFU2125	TMTFL2125	-	-

10 pcs / pack

Damon compatible*

DRITTO / STRAIGHT 14"		DRITTO / STRAIGHT 14"	
.016	STTM016	.016x.016	STTM1616
.018	STTM018	.016x.022	STTM1622
.020	STTM020	.017x.025	STTM1725
.028	STTM028	.018x.018	STTM1818
.032	STTM032	.018x.025	STTM1825
.036	STTM036	.019x.025	STTM1925
.040	STTM040	.020x.020	STTM2020
.045	STTM045	.021x.025	STTM2125
.051	STTM051		

10 pcs / pack



* Damon è un marchio registrato della Ormco Corporation / Damon is a trademark by Ormco Corporation
 * TMA è un marchio registrato della ditta ORMCO / TMA is a trademark of ORMCO

- Merce disponibile / Goods available
- Merce a richiesta / Goods on request

Archi con post dritto / Straight post archwires

Si definiscono superiori gli archi che vanno dalla misura 34 mm alla misura 44 mm. Sono invece considerati archi inferiori dalla misura 22 mm alla misura 32 mm, con incrementi di 2 mm.

Upper archwires are 34 to 44 mm, lower are 22 to 32 mm, with increments of 2 mm.



POSTED Archwires

Damon compatible*

	TRUEARCH I	EUROARCH I	EUROARCH II
.016	PSTF016*	PSEF016*	-
.018	PSTF018*	PSEF018*	-
.020	PSTF020*	PSEF020*	-
.016x.016	PSTF1616*	PSEF1616*	-
.016x.022	PSTF1622*	PSEF1622*	-
.016x.025	-	-	PSEF3625*
.017x.025	PSTF1725*	PSEF1725*	PSEF3725*
.018x.025	PSTF1825*	PSEF1825*	-
.019x.025	PSTF1925*	PSEF1925*	PSEF3925*
.020x.020	PSTF2020*	PSEF2020*	-
.021x.025	PSTF2125*	PSEF2125*	PSEF3125*

10 pcs / pack

* Inserire le misure in 2 mm di incremento

* Insert preferred millimeter size, available in 2mm increments

Upper 34 to 44mm - Lower 22 to 33mm

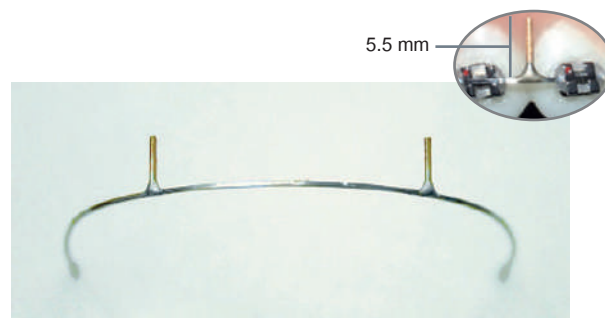

Archi in acciaio looped, posted / Stainless Steel looped, posted archwires

Si definiscono archi superiori quelli dalla misura 34mm alla misura 44mm; sono invece inferiori quelli dalla misura 22mm alla misura 32 mm, con incrementi di 2 mm. Per ordinare correttamente gli archi occorre completare i codici sotto citati inserendo la misura corretta, individuabile mediante la misurazione della distanza dall'angolo incisale distale alla parte incisale del laterale opposto.

Upper archwires are 34 to 44 mm, lower are 22 to 32 mm, with increments of 2mm. To order the correct size of the looped arch, measure along incisal edge from distal of lateral to distal of opposite lateral with a ruler.

T-LOOP Archwires

	TRUEARCH I
	2 LOOP
.016x.022	TLTF1622*
.017x.025	TLTF1725*
.019x.025	TLTF1925*

10 pcs / pack



* Inserire le misure in 2 mm di incremento

* Insert preferred millimeter size, available in 2mm increments

Upper 34 to 44mm - Lower 22 to 33mm

KEYHOLE Archwires

	TRUEARCH I	
	2 LOOP	4 LOOP
.016x.022	KHTF21622*	KHTF41622*
.017x.025	KHTF21725*	KHTF41725*
.019x.025	KHTF21925*	KHTF41925*

10 pcs / pack



2 Loop



4 Loop

* Inserire le misure in 2 mm di incremento

* Insert preferred millimeter size, available in 2mm increments

Upper 34 to 44mm - Lower 22 to 33mm

■ Merce disponibile / Goods available

■ Merce a richiesta / Goods on request

Molle in acciaio / Stainless Steel springs

Le molle in acciaio, disponibili nel pratico confezionamento a spoletta, sono fabbricate in due varianti: aperte e chiuse.

Our stainless steel open and closed coil springs are available on 21" spools.

Molla aperta / Open Spring

.010x.028	SSOC1028
.010x.030	SSOC1030
.010x.036	SSOC1036
21" spool	



Molla chiusa / Closed Spring

.010x.030	SSCC1030
21" spool	



Micro Stop da grippare / Crimpable Micro-Stops

Usato come ancoraggio per limitare i movimenti dentali, può scorrere sul filo e lo si può bloccare dove si desidera con l'apposita pinza.

Used as an anchor to limit tooth movement, it can scroll on the wire and be blocked where required with the specific plier.

Stop chiuso / Closed-stop

Large .020 to .019x.025	CSTOPLG
Small .012 to .018	CSTOPSM
50 pcs / pack	



Stop aperto / Open-stop

.018 to .021x.025	CSTOPOW
10 pcs / pack	



Ganci chirurgici da grippare / Surgical Hooks

I ganci chirurgici da grippare sono dotati di gancio a palla e fabbricati in due varianti: chiusi ed aperti.

Open and Closed ball surgical hooks.

Ganci chirurgici a sfera / Ball surgical hooks Ø 2mm

	.018	.022	.018x.025	.021x.025
1- Open DX	ARHK630CR	ARHK631CR	-	-
1- Open SX	ARHK630CL	ARHK631CL	-	-
2- Closed	ARHK632C	ARHK633C	-	-
3- Open - Universal	-	-	9200103	
4- Closed Straight	-	-	SURHK620C	SURHK621C
10 pcs / pack				

Aperto Curvo / Open Curved



Chiuso Curvo / Closed Curved

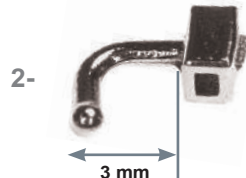

Aperto Universale / Open Universal

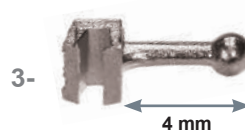

Chiuso Dritto / Closed Straight

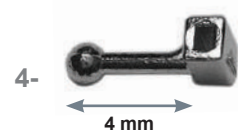

- Merce disponibile / Goods available
- Merce a richiesta / Goods on request

Barre palatali / Palatal Bars

Le barre palatali sono realizzate in acciaio, con diametro .036"; vengono usate per la rotazione e la distalizzazione dei molari.
Palatal Bars are realized with stainless steel, with .036" diameter. They are used for molar rotation and distalization.

Palatal Bars

	Mesial Loop	Distal Loop
37 mm	PAB37	PAB137
39 mm	PAB39	PAB139
41 mm	PAB41	PAB141
43 mm	PAB43	PAB143
45 mm	PAB45	PAB145
47 mm	PAB47	PAB147
49 mm	PAB49	PAB149
51 mm	PAB51	PAB151
53 mm	PAB53	PAB153
5 pcs / pack		

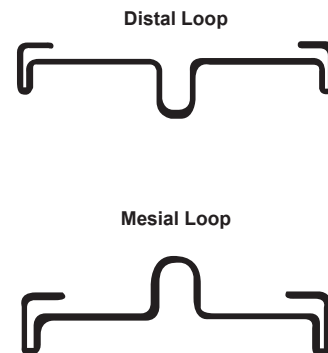

Occhielli in composito / Composite eyelets

Occhielli in composito, spesso usati in zone affollate per retainer. Apertura fino a .021" x .025".
Composite Eyelets, used for retainer. Opening until .021" x .025"

Composite Eyelets

CMEYE
5 pcs / pack



Bottoni Linguali / Lingual Buttons

Bottoni linguali, costruiti con un particolare design arrotondato, per garantire un ottimo comfort al paziente.

Lingual buttons realized with a particular round design to guarantee an excellent comfort for the patient.

Bottoni Linguali / Lingual Buttons

	Bondable
A- Flat - 10 pcs / pack	93-002-02
B- Contoured - 20 pcs / pack	BLBC20
C- Round - 10 pcs / pack	93-002-01
D- Flat - Weldable - 10 pcs / pack	93-001-01



Bottoni Linguali con cleats

Lingual Cleats Buttons

F - Lingual Cleat Buttons	93-004-01
10 pcs / pack	



F - Lingual Cleat Buttons

Bottoni per Estrusione / Extrusion Hooks

A- Extrusion Hooks	EXHK
B- Extrusion Hooks	EXHKO
10 pcs / pack	

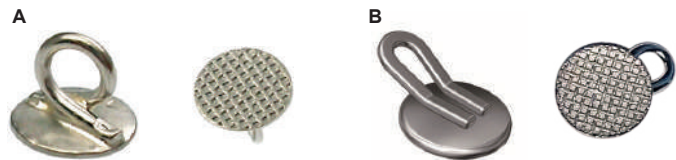

Bottone per estrusione con catena / Extrusion Button with chain

Bottone ideale per l'estrusione di denti inclusi. Rivestito in oro 14k per escludere possibilità di allergie e retrazioni.

Ideal button for the extrusion of internal teeth. It is 14 carats gold covered to exclude possible allergies and retractions.

Extrusion Button

Gold Extrusion hook with chain	EXHK14K
1 pc / pack with chain	



Bottoni in Ceramica / Ceramic Buttons

Bottoni in ceramica, mantengono l'aspetto trasparente con le mascherine come fissaggio per gli elastici. Funzionano sia lingualmente che labialmente. Base anatomica a griglia per garantire una forte adesione su tutti i tipi di denti.

They maintain the transparent look with aligners as anchorage for elastics. They work lingually & labially. Anatomical mesh base for strong bond that fits all kinds of teeth.

Ceramic Buttons

CLB10
5 pcs / pack



■ Merce disponibile / Goods available

■ Merce a richiesta / Goods on request

Legature metalliche preformate / Pre-cut ligature ties

Pre-cut ligature ties

.010 - Standard	SLT010
500 pcs / pack	



Legature metalliche Kobayashi / Kobayashi ligature ties

Kobayashi ligature ties

Short	
.012	SKH012
.014	SKH014
100 pcs / pack	



Corta / Short

Long	
.012	KH012
.014	KH014
100 pcs / pack	



Lunga / Long

Legature preformate lunghe / Long pre-cut ligature ties

Stainless Steel ligature ties

Long	
.008	LT008
.009	LT009
.010	LT010
.011	LT011
.012	LT012
1000 pcs / pack	



.014	LT014
500 pcs / pack	

Filo in matassa / Spooled bulk ligature wire

Spooled bulk ligature ties

	20 g.	450 g.
.008	SS60120	SBLW108
.009	-	SBLW109
.010	SS60125	SBLW110
.011	-	SBLW111
.012	SS60130	SBLW112
Spool		



■ Merce disponibile / Goods available

■ Merce a richiesta / Goods on request

Estetica / *Aesthetics*

Archi estetici / Ultraesthetic archwires

La linea Ultraesthetic di archi ed accessori nasce per offrire un'ampia gamma di possibilità estetiche tali da soddisfare sia le richieste cliniche, sia le esigenze estetiche dei pazienti. La nostra linea di archi Ultraesthetic consente di ottenere alte prestazioni ed efficaci trattamenti, senza compromettere tecniche e risultati. Il rivestimento estetico non riduce le prestazioni del filo.

Ultraesthetic archwires and accessories are conceived to offer a wide range of aesthetic possibilities, in order to meet both clinical and aesthetic needs. Ultraesthetic archwires allow high performances and efficient treatments without compromising techniques and results. Aesthetic coating doesn't reduce archwire performance.



Ni-Ti Aesthetic archwires

	TRUEARCH I	
	UPPER	LOWER
.012	SETFU012T	SETFL012T
.014	SETFU014T	SETFL014T
.016	SETFU016T	SETFL016T
.018	SETFU018T	SETFL018T
.020	SETFU020T	SETFL020T
.016x.022	SETFU1622T	SETFL1622T
.017x.025	SETFU1725T	SETFL1725T
.018x.018	SETFU1818T	SETFL1818T
.018x.025	SETFU1825T	SETFL1825T
.019x.025	SETFU1925T	SETFL1925T
.020x.020	SETFU2020T	SETFL2020T
.021x.025	SETFU2125T	SETFL2125T
5 pcs / pack		

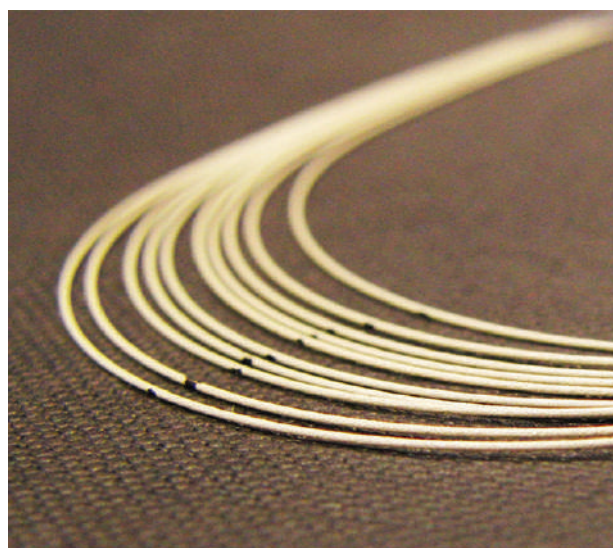

Stainless Steel Aesthetic archwires

	TRUEARCH I		EUROARCH I	
	UPPER	LOWER	UPPER	LOWER
.014	SSTFU014T	SSTFL014T	SSEFU014T	SSEFL014T
.016	SSTFU016T	SSTFL016T	SSEFU016T	SSEFL016T
.018	SSTFU018T	SSTFL018T	SSEFU018T	SSEFL018T
.020	SSTFU020T	SSTFL020T	SSEFU020T	SSEFL020T
.016x.022	SSTFU1622T	SSTFL1622T	SSEFU1622T	SSEFL1622T
.017x.025	SSTFU1725T	SSTFL1725T	SSEFU1725T	SSEFL1725T
.018x.018	SSTFU1818T	SSTFL1818T	SSEFU1818T	SSEFL1818T
.018x.025	SSTFU1825T	SSTFL1825T	SSEFU1825T	SSEFL1825T
.019x.025	SSTFU1925T	SSTFL1925T	SSEFU1925T	SSEFL1925T
.020x.020	SSTFU2020T	SSTFL2020T	SSEFU2020T	SSEFL2020T
.021x.025	SSTFU2125T	SSTFL2125T	SSEFU2125T	SSEFL2125T
5 pcs / pack				

Attacchi in ceramica / Ceramic Brackets

Attacchi in ceramica Iceberg, prodotti in pura allumina al 99,99%, per adattarsi alle varie gradazioni naturali dei denti. La basetta con ritenzioni meccaniche permette un'altissima adesione, usando i più comuni compositi. Per l'adesione è consigliato il nostro prodotto Ortho Flow, per la sua natura fluida e trasparente.

99.99 % pure alumina ceramic brackets that adapt to natural teeth colour shade. The base with mechanical retention allows a high bond, employing the most common composites. For its transparent and fluid nature, our Ortho Flow is recommended for bonding.

Roth refill

UPPER	TORQUE	ANGULATION	.018		.022	
			RIGHT	LEFT	RIGHT	LEFT
U1	12°	5°	31-211-11	31-211-21	31-221-11	31-221-21
U2	8°	9°	31-211-12	31-211-22	31-221-12	31-221-22
U3 w/hook	-2°	13°	31-211-13HK	31-211-23HK	31-221-13HK	31-221-23HK
U4,5	-7°	0°	31-211-14	31-221-24	31-221-14	31-221-24
LOWER						
L1/L2	-1°	2°	31-211-31		31-221-31	
L3 w/hook	-11°	7°	31-211-43HK	31-211-33HK	31-221-43HK	31-221-33HK
L4	-17°	-1°	31-211-44	31-211-34	31-221-44	31-221-34
L5	-22°	-1°	31-211-45	31-211-35	31-221-45	31-221-35
1 pc / pack						



Roth kit

UPPER / LOWER	.018	.022
U/L 3 w/hook	0124S-202	0124S-201
20 pcs / pack - 1 case		

MBT refill

UPPER	TORQUE	ANGULATION	.018		.022	
			RIGHT	LEFT	RIGHT	LEFT
U1	17°	4°	31-311-11	31-311-21	31-321-11	31-321-21
U2	10°	8°	31-311-12	31-311-22	31-321-12	31-321-22
U3 w/hook	-7°	8°	31-311-13HK	31-311-23HK	31-321-13HK	31-321-23HK
U4,5	-7°	0°	31-311-14	31-311-24	31-321-14	31-321-24
LOWER						
L1/L2	-6°	0°	31-311-31		31-321-31	
L3 w/hook	-6°	3°	31-311-43HK	31-311-33HK	31-321-43HK	31-321-33HK
L4	-12°	-2°	31-311-44	31-311-34	31-321-44	31-321-34
L5	-17°	-2°	31-311-45	31-311-35	31-321-45	31-321-35
1 pc / pack						



MBT kit

UPPER / LOWER	.018	.022
U/L 3 w/hook	0134S-302	0134S-301
20 pcs / pack - 1 case		

Edgewise refill

	TORQUE	ANGULATION	.018		.022	
			RIGHT	LEFT	RIGHT	LEFT
U1	0°	0°	31-111-11	31-111-21	31-121-11	31-121-21
U2	0°	0°	31-111-12	31-111-22	31-121-12	31-121-22
U3 / L3	0°	0°	31-111-13	31-111-23	31-121-13	31-121-23
U3 w/hook	0°	0°	31-111-13HK	31-111-23HK	31-121-13HK	31-121-23HK
L3 w/hook	0°	0°	31-111-43HK	31-111-33HK	31-121-43HK	31-121-33HK
U4,5 / L4,5	0°	0°	31-111-14	31-111-24	31-121-14	31-121-24
L1,2	0°	0°	31-111-31		31-121-31	
1 pc / pack						

Edgewise kit

UPPER / LOWER	.018	.022
U/L 5 - 5	0114S-102	0114S-101
U/L 3 w/hook	0114S-103	0114S-104
20 pcs / pack - 1 case		

- Merce disponibile / Goods available
- Merce a richiesta / Goods on request

Attacchi in ceramica self-ligating / Ceramic Brackets self ligating

Attacchi SLB+ in ceramica allumina al 99,99%, Self Ligating o autolegante, con sportellino in acciaio satinato e clip metallico. La basetta ed il corpo dell'attacco sono realizzati con una tecnica disegnata a nido d'ape, che garantisce una forte tenuta ma anche una facile rimozione. Si consiglia l'utilizzo del bonding Ortho Flow.

99.99 % pure alumina ceramic self ligating brackets, with satin steel flap with metal clip. Base and main part designed with a honeycomb structure special technique for secure bonding and easy removal. Our Ortho Flow is recommended for bonding.



Passive



.016 .018 .018x.018

Interactive



.020x.020

Active



.018x.025 .019x.025

Roth refill

UPPER	TORQUE	ANGULATION	Width (mm)	.018		.022	
				RIGHT	LEFT	RIGHT	LEFT
U1	11°	5°	3.2	104-11	104-21	114-11	114-21
U2	8°	9°	2.95	104-12	104-22	114-12	114-22
U3 w/hook	-2°	8°	3.5	104-13(H)	104-23(H)	114-13(H)	114-23(H)
U4 w/hook	-7°	0°	3.2	104-14(H)	104-24(H)	114-14(H)	114-24(H)
U5 w/hook	-7°	0°	3.2	104-15(H)	104-25(H)	114-15(H)	114-25(H)
LOWER							
L1/L2	0°	0°	2.85	104-41/42	104-31/32	114-41/42	114-31/32
L3 w/hook	-11°	7°	3.5	104-43(H)	104-33(H)	114-43(H)	114-33(H)
L4 w/hook	-17°	0°	3.2	104-44(H)	104-34(H)	114-44(H)	114-34(H)
L5 w/hook	-17°	0°	3.2	104-45(H)	104-35(H)	114-45(H)	114-35(H)

1 pc / pack

Roth kit

UPPER / LOWER	.018	.022
U/L5-5, 3/4/5 w/hook	104-553	114-553
20 pcs / pack - 1 case		

MBT refill

UPPER	TORQUE	ANGULATION	Width (mm)	.018		.022	
				RIGHT	LEFT	RIGHT	LEFT
U1	17°	4°	3.2	124-11	124-21	134-11	134-21
U2	10°	8°	2.95	124-12	124-22	134-12	134-22
U3 w/hook	0°	8°	3.5	124-13(H)	124-23(H)	134-13(H)	134-23(H)
U4 w/hook	-7°	0°	3.2	124-14(H)	124-24(H)	134-14(H)	134-24(H)
U5 w/hook	-7°	0°	3.2	124-15(H)	124-25(H)	134-15(H)	134-25(H)
LOWER							
L1/L2	6°	0°	2.85	124-41/42	124-31/32	134-41/42	134-31/32
L3 w/hook	0°	3°	3.5	124-43(H)	124-33(H)	134-43(H)	134-33(H)
L4 w/hook	-12°	0°	3.2	124-44(H)	124-34(H)	134-44(H)	134-34(H)
L5 w/hook	-12°	0°	3.2	124-45(H)	124-35(H)	134-45(H)	134-35(H)

1 pc / pack

MBT kit

UPPER / LOWER	.018	.022
U/L5-5, 3/4/5 w/hook	124-553	134-553
20 pcs / pack - 1 case		

■ Merce disponibile / Goods available

■ Merce a richiesta / Goods on request

Attacchi in zaffiro / Sapphire Brackets

Attacchi in zaffiro Mimetic, sono brackets completamente trasparenti, realizzati in zaffiro ottenuto sinteticamente, con proprietà di durezza, traslucenza identiche allo zaffiro naturale garantendo una totale mimetizzazione con la struttura dentale. Mimetic viene prodotto con tecnologie 3D per adattarsi perfettamente all'anatomia del dente, offrendo massimo comfort al paziente. La basetta è realizzata con una tecnica RMM ne garantisce una forte tenuta ed al tempo stesso una facile rimozione. Possono essere usati i più comuni compositi per il bonding.

Mimetic brackets completely transparent are realized in sapphire synthetically obtained, with unique properties of translucency and hardness, identical to the natural sapphire with a total camouflage to the dental structure. Mimetic is realized with advanced 3D technology to offer a great adaptation to the tooth anatomy. Its base is realized with RMM technique for secure bonding and easy removal. The common bonding composites can be used.



Roth refill

UPPER	TORQUE	ANGULATION	.018		.022	
			RIGHT	LEFT	RIGHT	LEFT
U1	11°	5°	181-101	181-201	221-101	221-201
U2	8°	9°	181-102	181-202	221-102	221-202
U3 w/hook	-2°	8°	181-133	181-233	221-133	221-233
U4,5	-7°	0°	181-104		221-104	
LOWER						
L1/L2	0°	0°	181-312		221-312	
L3 w/hook	-11°	7°	181-433	181-333	221-433	221-333
L4	-17°	3°	181-304		221-304	
L5	-21°	6°	181-305		221-305	
1 pc / pack						

Roth kit

UPPER / LOWER	.018	.022
U/L 3 w/hook	181-505	221-505
U/L 3/4/5 w/hook	181-555	221-555
20 pcs / pack - 1 case		

MBT refill

UPPER	TORQUE	ANGULATION	.018		.022	
			RIGHT	LEFT	RIGHT	LEFT
U1	17°	4°	182-101	182-201	222-101	222-201
U2	10°	8°	182-102	182-202	222-102	222-202
U3 w/hook	0°	8°	182-133	182-233	222-133	222-233
U4,5	7°	0°	182-104		222-104	
LOWER						
L1/L2	-6°	0°	182-312		222-312	
L3 w/hook	0°	3°	182-333	182-433	222-333	222-433
L4	-12°	2°	182-304		222-304	
L5	-17°	2°	182-305		222-305	
1 pc / pack						



MBT kit

UPPER / LOWER	.018	.022
U/L 3 w/hook	182-505	222-505
U/L 3/4/5 w/hook	182-555	222-555
20 pcs / pack - 1 case		

Edgewise refill

UPPER / LOWER	TORQUE	ANGULATION	.018	.022
U1	0°	0°	180-101	220-101
U2	0°	0°	180-102	220-102
U3 / L3	0°	0°	180-103	220-103
U4,5 / L4,5	0°	0°	180-205	220-205
L1,2	0°	0°	180-312	220-312
1 pc / pack				

Edgewise kit

UPPER / LOWER	.018	.022
U/L 5 - 5	180-551	220-551
20 pcs / pack - 1 case		

■ Merce disponibile / Goods available

■ Merce a richiesta / Goods on request

Attacchi in Resina / Resin Brackets

Brackets in resina Mimetic, sono attacchi completamente trasparenti con slot metallico che ne garantisce resistenza e scorrevolezza al filo. La particolarità della resina di cui sono composti, non si decolora e non si macchia nel tempo, mimetizzandosi totalmente con la struttura dentale. Mimetic Resin hanno la basetta con ritenzione meccanica a forma di "coda di rondine", che permette all'attacco di aderire perfettamente al composito senza distacchi.

Mimetic resin brackets, completely transparent with metal slot which grants resistance and fluidity to the wire. The resin of which they are composed favours a camouflages with the tooth structure, thanks to its clear and plain surface, with any decoloration and stains during the time. Perfect bonding to the composite is given by a swallow-tail base, which grants mechanical retention.

Roth refill

UPPER	TORQUE	ANGULATION	Width (mm)	.018		.022	
				RIGHT	LEFT	RIGHT	LEFT
U1	11°	5°	3.2	600-11	600-21	610-11	610-21
U2	8°	9°	3.25	600-12	600-22	610-12	610-22
U3 w/hook	-2°	8°	3.8	600-13(H)	600-23(H)	610-13(H)	610-23(H)
U4	-7°	0°	3.5	600-14	600-24	610-14	610-24
U5	-7°	0°	3.5	600-15	600-25	610-15	610-25
LOWER							
L1/L2	0°	0°	3.15	600-41/42	600-31/32	610-41/42	610-31/32
L3 w/hook	-11°	7°	3.8	600-43(H)	600-33(H)	610-43(H)	610-33(H)
L4	-17°	0°	3.5	600-44	600-34	610-44	610-34
L5	-17°	0°	3.5	600-45	600-35	610-45	610-35
1 pc / pack							

MBT refill

UPPER	TORQUE	ANGULATION	Width (mm)	.018		.022	
				RIGHT	LEFT	RIGHT	LEFT
U1	17°	4°	3.5	620-11	620-21	630-11	630-21
U2	10°	8°	3.25	620-12	620-22	630-12	630-22
U3 w/hook	0°	8°	3.5	620-13(H)	620-23(H)	630-13(H)	630-23(H)
U4 w/hook	-7°	0°	3.2	620-14(H)	620-24(H)	630-14(H)	630-24(H)
U5 w/hook	-7°	0°	3.2	620-15(H)	620-25(H)	630-15(H)	630-25(H)
LOWER							
L1/L2	-6°	0°	3.15	620-41/42	620-31/32	630-41/42	630-31/32
L3 w/hook	0°	3°	3.5	620-43(H)	620-33(H)	630-43(H)	630-33(H)
L4 w/hook	-12°	0°	3.2	620-44(H)	620-34(H)	630-44(H)	630-34(H)
L5 w/hook	-12°	0°	3.2	620-45(H)	620-35(H)	630-45(H)	630-35(H)
1 pc / pack							

Edgewise refill

UPPER	TORQUE	ANGULATION	Width (mm)	.018		.022	
				RIGHT	LEFT	RIGHT	LEFT
U1	0°	0°	3.2	640-11	640-21	650-11	650-21
U2	0°	0°	3.15	640-12	640-22	650-12	650-22
U3 w/hook	0°	0°	3.2	640-13(H)	640-23(H)	650-13(H)	650-23(H)
U4 w/hook	0°	0°	3.2	640-14(H)	640-24(H)	650-14(H)	650-24(H)
U5 w/hook	0°	0°	3.2	640-15(H)	640-25(H)	650-15(H)	650-25(H)
LOWER							
L1/L2	0°	0°	3.15	640-41/42	640-31/32	650-41/42	650-31/32
L3 w/hook	0°	0°	3.2	640-43(H)	640-33(H)	650-43(H)	650-33(H)
L4 w/hook	0°	0°	3.2	640-44(H)	640-34(H)	650-44(H)	650-34(H)
L5 w/hook	0°	0°	3.2	640-45(H)	640-35(H)	650-45(H)	650-35(H)
1 pc / pack							

MIMETIC
RESIN BRACKETS

Roth kit

UPPER / LOWER	.018	.022
U/L 3 w/hook	600-551	
20 pcs / pack - 1 case		



MBT kit

UPPER / LOWER	.018	.022
U/L 3/4/5 w/hook	620-553	630-553
20 pcs / pack - 1 case		

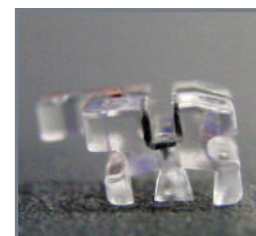

Edgewise kit

UPPER / LOWER	.018	.022
U/L 3/4/5 w/hook	640-553	650-553
20 pcs / pack - 1 case		

■ Merce disponibile / Goods available

■ Merce a richiesta / Goods on request

Attacchi Metallici / *Metal Brackets*

Attacchi Eclipse / Eclipse brackets

Attacchi Eclipse a basso profilo, per un maggior comfort ed una minore interferenza con i tessuti molli; identificazione permanente disto-gengivale ed alette progettate per una facile locazione delle legature. Il design dell'attacco permette un'ottima cementazione, adattandosi perfettamente alla morfologia del dente.

Low profile brackets for patient comfort and for minimal occlusion contact. Permanent mark on the distogingival; sweeping tie wing for easy and secure ties. Anatomically contoured to ensure the utmost in bond adhesion.

Roth refill

UPPER	TORQUE	ANGULATION	.018		.022	
			RIGHT	LEFT	RIGHT	LEFT
U1	12°	5°	RB212-11	RB212-21	RB222-11	RB222-21
U2	8°	9°	RB212-12	RB212-22	RB222-12	RB222-22
U3 w/hook	-2°	13°	RB212-13HK	RB212-23HK	RB222-13HK	RB222-23HK
U4,5	-7°	0°	RB212-14		RB222-14	
U4,5 w/hook	-7°	0°	RB212-14HK	RB212-24HK	RB222-14HK	RB222-24HK
LOWER						
L1/L2	-1°	0°	RB212-31		RB222-31	
L3 w/hook	-11°	7°	RB212-43HK	RB212-33HK	RB222-43HK	RB222-33HK
L4	-17°	0°	RB212-44		RB222-44	
L4 w/hook	-17°	0°	RB212-44HK	RB212-34HK	RB222-44HK	RB222-34HK
L5	-22°	0°	RB212-45		RB222-45	
L5 w/hook	-22°	0°	RB212-45HK	RB212-35HK	RB222-45HK	RB222-35HK
10 pcs / pack						



Roth kit

UPPER / LOWER	.018	.022
U/L 3 w/hook	RB13-212	RB22-23
U/L 3/4/5 w/hook	RB13-213	RB22-24
20 pcs / pack - 1 case		

MBT refill

UPPER	TORQUE	ANGULATION	.018		.022	
			RIGHT	LEFT	RIGHT	LEFT
U1	17°	4°	RB312-11	RB312-21	RB322-11	RB322-21
U2	10°	8°	RB312-12	RB312-22	RB322-12	RB322-22
U3 w/hook	-7°	8°	RB312-13HK	RB312-23HK	RB322-13HK	RB322-23HK
U4,5	-7°	0°	RB312-14		RB322-14	
U4,5 w/hook	-7°	0°	RB312-14HK	RB312-24HK	RB322-14HK	RB322-24HK
LOWER						
L1/L2	-6°	0°	RB312-31		RB322-31	
L3 w/hook	-6°	3°	RB312-43HK	RB312-33HK	RB322-43HK	RB322-33HK
L4	-12°	0°	RB312-44		RB322-44	
L4 w/hook	-12°	0°	RB312-44HK	RB312-34HK	RB322-44HK	RB322-34HK
L5	-17°	0°	RB312-45		RB322-45	
L5 w/hook	-17°	0°	RB312-45HK	RB312-35HK	RB322-45HK	RB322-35HK
10 pcs / pack						



MBT kit

UPPER / LOWER	.018	.022
U/L 3 w/hook	RB13-12	RB32-23
U/L 3/4/5 w/hook	RB13-24	RB32-24
20 pcs / pack - 1 case		

Edgewise refill

UPPER / LOWER	TORQUE	ANGULATION	.018	.022
U1	0	0°	RB112-11	RB122-11
U2	0°	0°	RB112-22	RB122-22
U3 / L3	0°	0°	RB112-13	RB122-13
UL3 / LR3 w/hook	0°	0°	RB112-23HK	RB122-23HK
UR3 / LL3 w/hook	0°	0°	RB112-13HK	RB122-13HK
U4 / U5 - L4 / L5	0°	0°	RB112-14	RB122-14
L1 / L2	0°	0°	RB112-31	RB122-31
10 pcs / pack				

Brackets ID quadrant colored

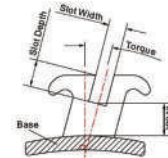
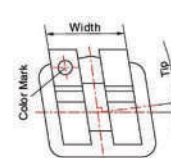
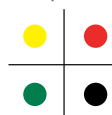

Edgewise kit

UPPER / LOWER	.018	.022
U/L 5 - 5	RB12-11	RB12-20
U/L 3 w/hook	RB12-112	RB12-23
20 pcs / pack - 1 case		

■ Merce disponibile / Goods available

■ Merce a richiesta / Goods on request

Attacchi Eclipse / Eclipse brackets

Ricketts refill

			.018	
UPPER	TORQUE	ANGULATION	RIGHT	LEFT
U1	22°	5°	RB421-11	RB421-21
U2	14°	8°	RB421-12	RB421-22
U3 w/hook	7°	7°	RB421-13HK	RB421-23HK
U4,5	-7°	0°	RB421-14	
U4,5 w/hook	-7°	0°	RB421-14HK	RB421-24HK
LOWER				
L1/L2	0°	0°	RB421-31	
L3 w/hook	7°	5°	RB421-43HK	RB421-33HK
L4	-11°	0°	RB421-44	
L4 w/hook	-17°	0°	RB421-44HK	RB421-34HK
L5	-17°	0°	RB421-45	
L5 w/hook	-17°	0°	RB421-45HK	RB421-35HK
10 pcs / pack				

Ricketts kit

UPPER / LOWER	.018
U/L 3 w/hook	RB21-02
20 pcs / pack - 1 case	

Attacchi Bright V-slot / V-slot brackets

La linea Bright V-slot completa la gamma delle possibilità tecniche disponibili oggi in commercio; l'alta qualità dell'attacco permette di soddisfare a pieno tutte le esigenze funzionali e il comfort del paziente.

Bright line is a further technical possibility; high quality brackets to accomplish functional needs and patient comfort.

Roth Bright refill

			.018		.022	
UPPER	TORQUE	ANGULATION	RIGHT	LEFT	RIGHT	LEFT
U1	12°	5°	VSRUR118 ●	VSRUL118 ●	VSRUR122 ●	VSRUL122 ●
U2	8°	9°	VSRUR218 ●	VSRUL218 ●	VSRUR222 ●	VSRUL222 ●
U3 w/hook	0°	11°	VSRUR319 ●	VSRUL319 ●	VSRUR323 ●	VSRUL323 ●
U4,5	-7°	0°	VSRU418 ●●		VSRU422 ●●	
U4,5 w/hook	-7°	0°	VSRUR419 ●	VSRUL419 ●	VSRUR423 ●	VSRUL423 ●
LOWER						
L1/L2	0°	0°	VSRL118		VSRL122	
L3 w/hook	-11°	5°	VSRLR319 ●	VSRL419 ●	VSRLR323 ●	VSRL423 ●
L4	-17°	0°	VSRL418 ○○		VSRL422 ○○	
L4 w/hook	-17°	0°	VSRLR419 ●	VSRL419 ●	VSRLR423 ●	VSRL423 ●
L5	-22°	0°	VSRL518 ●●		VSRL522 ●●	
L5 w/hook	-22°	0°	VSRLR519 ●●	VSRL519 ●●	VSRLR523 ●●	VSRL523 ●●
10 pcs / pack						



Attacco con slot verticale
V-slot brackets



Roth kit

UPPER / LOWER	.018	.022
U/L 3 w/hook	KTVSR1935	KTVSR2335
U/L 3/4/5 w/hook	KTVSR1955	KTVSR2355
20 pcs / pack - 1 case		

Dual Dimension kit

.018 U/L 1,2	-	.022 U/L 3,4,5
U/L 3 w/hook		KTVSRD2335
U/L 3/4/5 w/hook		KTVSRD2355
20 pcs / pack - 1 case		

■ Merce disponibile / Goods available
 ■ Merce a richiesta / Goods on request

Attacchi Maximus / Maximus brackets

Gli attacchi Maximus sono la scelta ideale per tutti i pazienti, indicati anche per coloro che sono sensibili al nickel. Realizzati in tecnica M.I.M in un solo pezzo, quindi senza saldature. Presentano una basetta anatomica e molto ritentiva; l'attacco è completamente privo di spigoli in modo tale da restituire al paziente il massimo del comfort.

Maximus brackets are the ideal choice for all patients, also suitable for those who are sensitive to nickel. They are produced by Metal Injection Molding (MIM) in one piece so without welding. They have an anatomical and retentive base; the bracket is completely free of corners in order to give back to the patient the maximum comfort.

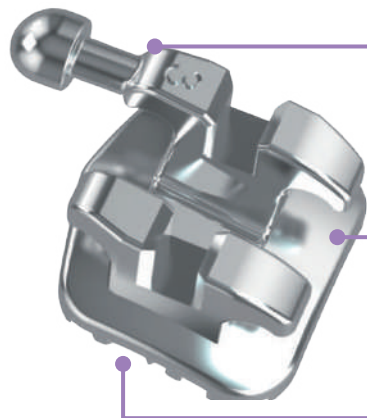

Basso profilo.
Design studiato per facilitare la legatura.
Low profile wing. Design for easy ligating.

Basetta sabbiata.
Sand Blasted base.

Tecnologia MIM.
MIM technology.



Roth refill

UPPER	TORQUE	ANGULATION	.018		.022	
			RIGHT	LEFT	RIGHT	LEFT
U1	12°	5°	MX411-11	MX411-21	MX421-11	MX421-21
U2	8°	9°	MX411-12	MX411-22	MX421-12	MX421-22
U3 w/hook	-2°	10°	MX411-13H	MX411-23H	MX421-13H	MX421-23H
U4,5	-7°	0°	MX411-14		MX421-14	
U4,5 w/hook	-7°	0°	MX411-14H	MX411-24H	MX421-14H	MX421-24H
LOWER						
L1/L2	-1°	0°	MX411-41		MX421-41	
L3 w/hook	-11°	7°	MX411-43H	MX411-33H	MX421-43H	MX421-33H
L4	-17°	0°	MX411-44	MX411-34	MX421-44	MX421-34
L4 w/hook	-17°	0°	MX411-44H	MX411-34H	MX421-44H	MX421-34H
L5	-22°	0°	MX411-45	MX411-35	MX421-45	MX421-35
L5 w/hook	-22°	0°	MX411-45H	MX411-35H	MX421-45H	MX421-35H
10 pcs / pack						

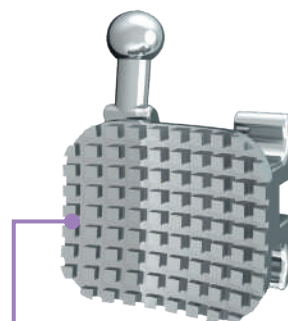

Basetta realizzata in un solo pezzo con 80 mesh.
One-piece construction with 80 mesh base.

Roth kit

UPPER / LOWER	.018	.022
U/L 3 w/hook	MX411-01K	MX421-01K
U/L 3/4/5 w/hook	MX411-02K	MX421-02K
20 pcs / pack - 1 case		

MBT refill

UPPER	TORQUE	ANGULATION	.018		.022	
			RIGHT	LEFT	RIGHT	LEFT
U1	17°	4°	MX511-11	MX511-21	MX521-11	MX521-21
U2	10°	8°	MX511-12	MX511-22	MX521-12	MX521-22
U3 w/hook	-7°	8°	MX511-13H	MX511-23H	MX521-13H	MX521-23H
U4,5	-7°	0°	MX511-14		MX521-14	
U4,5 w/hook	-7°	0°	MX511-14H	MX511-24H	MX521-14H	MX521-24H
LOWER						
L1/L2	-6°	0°	MX511-41		MX521-41	
L3 w/hook	-6°	3°	MX511-43H	MX511-33H	MX521-43H	MX521-33H
L4	-12°	2°	MX511-44	MX511-34	MX521-44	MX521-34
L4 w/hook	-12°	2°	MX511-44H	MX511-34H	MX521-44H	MX521-34H
L5	-17°	2°	MX511-45	MX511-35	MX521-45	MX521-35
L5 w/hook	-17°	2°	MX511-45H	MX511-35H	MX521-45H	MX521-35H
10 pcs / pack						

MBT kit

UPPER / LOWER	.018	.022
U/L 3 w/hook	MX511-01K	MX521-01K
U/L 3/4/5 w/hook	MX511-02K	MX521-02K
20 pcs / pack - 1 case		

■ Merce disponibile / Goods available

■ Merce a richiesta / Goods on request

Attacchi Eclipse smart active / Eclipse smart active brackets

Il bracket autolegante Eclipse Smart Active è un attacco interattivo. La sua clip entra nello slot, utilizzando gli archi di forma rettangolare, ed interagisce con gli stessi; quando si utilizzano gli archi di piccola sezione, vengono definiti passivi in quanto non interagisce con la clip.

Eclipse Smart Active self-ligating bracket can be "interactive", as its clip enters the slot, interacting with rectangular archwires; it can also be "passive" as the smaller wires do not interact with the clip.

Clip interattiva / Interactive clip

- **Passive:** .016 - .018 - .018 x .018
- **Interactive:** .020 x .020
- **Active:** .018 x .025 - .019 x .025

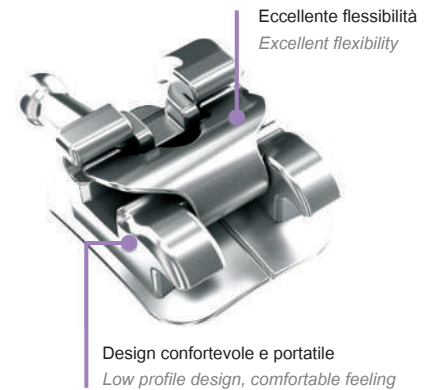

Roth refill

				.022	
UPPER	TORQUE	ANGULATION	Width (mm)	RIGHT	LEFT
U1	11°	5°	2.9	113-11	113-21
U2	8°	9°	2.7	113-12	113-22
U3 w/hook	-2°	8°	2.95	113-13H	113-23H
U4 w/hook	-7°	0°	2.95	113-14H	113-24H
U5 w/hook	-7°	0°	2.95	113-15H	113-25H
LOWER					
L1/L2	0°	0°	2.5	113-41/42	113-31/32
L3 w/hook	-11°	7°	2.95	113-43H	113-33H
L4 w/hook	-17°	0°	2.95	113-44H	113-34H
L5 w/hook	-17°	0°	2.95	113-45H	113-35H
1 pc / pack					

Roth kit

UPPER / LOWER	.022
U/L 3/4/5 w/hook	113-553
20 pcs / pack - 1 case	

MBT refill

				.022	
UPPER	TORQUE	ANGULATION	Width (mm)	RIGHT	LEFT
U1	17°	4°	2.9	133-11	133-21
U2	10°	8°	2.7	133-12	133-22
U3 w/hook	-0°	8°	2.95	133-13H	133-23H
U4 w/hook	-7°	0°	2.95	133-14H	133-24H
U5 w/hook	-7°	0°	2.95	133-15H	133-25H
LOWER					
L1/L2	-6°	0°	2.5	133-41/42	133-31/32
L3 w/hook	0°	3°	2.95	133-43H	133-33H
L4 w/hook	-12°	0°	2.95	133-44H	133-34H
L5 w/hook	-12°	0°	2.95	133-45H	133-35H
1 pc / pack					



MBT kit

UPPER / LOWER	.022
U/L 3/4/5 w/hook	133-553
20 pcs / pack - 1 case	



Strumento per brackets - Active

Tool for self-ligating brackets	110-000
1 pc / pack	

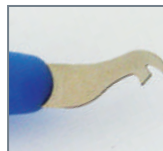

■ Merce disponibile / Goods available

■ Merce a richiesta / Goods on request

Attacchi Eclipse smart passive / Eclipse smart passive brackets

Gli attacchi Eclipse Smart Passive self ligating, sono realizzati con tecnologia MIM (Metal Injection Moulding), dotati di uno slot con chiusura a scorrimento, permette di posizionare l'arco in maniera pratica e veloce. La basetta romboidale ne facilita il posizionamento, disponibili nelle prescrizioni Roth - MBT .018 e .022.

Eclipse Smart Passive self ligating brackets are endowed of a special clip that allows an easy and fast archwires placement, avoiding the frictions usually generated between arch and ligatures ties; it reduces plaque accumulation. The brackets are realized with MIM (metal injection moulding) technology and nickel free steel. They have a rhomboid base to enable easy placement. Roth / MBT - .018 and .022 slots available.



Roth refill

UPPER	TORQUE	ANGULATION	Width (mm)	.018		.022	
				RIGHT	LEFT	RIGHT	LEFT
U1	12°	5°	3.0	211-11	211-21	221-11	221-21
U2	8°	9°	2.8	211-12	211-22	221-12	221-22
U3 w/hook	-2°	13°	3.0	211-13HK	211-23HK	221-13HK	221-23HK
U4 / U5	-7°	0°	3.0	211-14		221-14	
U4 w/hook	-7°	0°	3.0	211-14HK	211-24HK	221-14HK	221-24HK
U5 w/hook	-7°	0°	3.0	211-15HK	211-25HK	221-15HK	221-25HK
LOWER							
L1/L2	-1°	2°	2.6	211-31		221-31	
L3 w/hook	-11°	7°	3.0	211-43HK	211-33HK	221-43HK	221-33HK
L4	-17°	-1°	3.0	211-44		221-44	
L4 w/hook	-17°	-1°	3.0	211-44HK	211-34HK	221-44HK	221-34HK
L5	-22°	-1°	3.0	211-45		221-45	
L5 w/hook	-22°	-1°	3.0	211-45HK	211-35HK	221-45HK	221-35HK
1 pc / pack							



Roth kit

UPPER / LOWER	.018	.022
U/L 3 w/hook	211-00HK	221-00HK
U/L 3/4/5 w/hook	211-00BHK	221-00BHK
20 pcs / pack - 1 case		

MBT refill

UPPER	TORQUE	ANGULATION	.018		.022	
			RIGHT	LEFT	RIGHT	LEFT
U1	17°	4°	311-11	311-21	321-11	321-21
U2	10°	8°	311-12	311-22	321-12	321-22
U3 w/hook	-7°	8°	311-13HK	311-23HK	321-13HK	321-23HK
U4 / U5	-7°	0°	311-14		321-14	
U4 w/hook	-7°	0°	311-14HK	311-24HK	321-14HK	321-24HK
U5 w/hook	-7°	0°	311-15HK	311-25HK	321-15HK	321-25HK
LOWER						
L1/L2	-6°	0°	311-31		321-31	
L3 w/hook	-6°	3°	311-43HK	311-33HK	321-43HK	321-33HK
L4	-12°	2°	311-44		321-44	
L4 w/hook	-12°	2°	311-44HK	311-34HK	321-44HK	321-34HK
L5	-17°	2°	311-45		321-45	
L5 w/hook	-17°	2°	311-45HK	311-35HK	321-45HK	321-35HK
1 pc / pack						

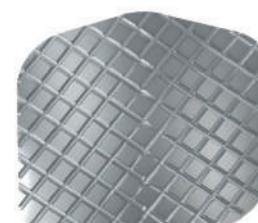

MBT kit

UPPER / LOWER	.018	.022
U/L 3 w/hook	311-00HK	321-00HK
U/L 3/4/5 w/hook	311-00BHK	321-00BHK
20 pcs / pack - 1 case		

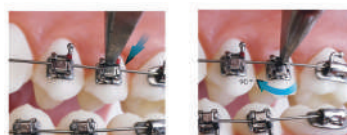

Strumento per brackets - Passive

Tool for self-ligating brackets	111-000
1 pc / pack	

■ Merce disponibile / Goods available

■ Merce a richiesta / Goods on request

Bande e Tubi / *Bands and Tubes*

Bande Molari GX / Molar Bands

Le bande anatomiche Ortho World, sono realizzate con il migliore acciaio medicale ed hanno l'interno sabbato, che ne garantisce un'ottima ritenzione ai cementi ortodontici. La marchiatura a laser permette una facile identificazione delle misure. Disponibili nelle misure da 1 a 32 per i molari mascellari e mandibolari e da 1 a 24 per i premolari (universali). Disponibile inoltre un'eccellente servizio di prepuntatura.

Molar bands, made with the best medical steel. Size 1 to 32 for molar bands; 1 to 24 for bicuspid bands (universal). Permanent laser identification markings and sandblasted for accurate cement adhesion. Dental World offers precision prepwelding of bands.

Kit Assortito / Assorted Kit

Bande Size	01	02	03	04	05	06	07	08	09	10	11	12	13	14	15	16	17	18	19	20	21	22	23	24	25	26	27	28	29	30	31	32
Trial Kit 80 pcs	-	-	-	-	-	2	2	4	4	4	6	6	10	10	10	6	6	4	4	2	-	-	-	-	-	-	-	-	-	-	-	-
Intro Kit 100 pcs	2	2	2	2	2	2	4	4	4	4	4	6	6	6	4	4	4	4	4	4	2	2	2	2	2	2	2	2	2	2	2	
Pro Kit 150 pcs	2	2	2	2	4	4	4	6	6	8	8	8	10	10	10	8	8	8	6	6	4	4	2	2	2	2	2	2	2	2	2	
Master Kit 300 pcs	4	4	6	6	6	8	8	14	14	16	16	18	18	18	18	16	16	14	14	8	8	6	6	6	4	4	4	4	4	4	4	

I Kit sono formati da 50% di bande destre e 50% di bande sinistre / 50% right bands and 50% left bands

Kit Bande Molari / Molar Bands Kit

	Trial Kit 80 pcs.	Intro Kit 100 pcs.	Pro Kit 150 pcs.	Master Kit 300 pcs.
UPPER	KMBU180	KMBU1100	KMBU1150	KMBU1300
LOWER	KMBL180	KMBL1100	KMBL1150	KMBL1300



Bande Anatomiche GX / Anatomical Bands



UL	MBUL1*
UR	MBUR1*

* aggiungere sempre la misura desiderata Es. MBUL1 25
* insert desired molar band size Ex. MBUL1 25



LL	MBLL1*
LR	MBLR1*

* aggiungere sempre la misura desiderata Es. MBLL1 25
* insert desired molar band size Ex. MBLL1 25

Bande Prepuntate GX / Prewelded Bands



ROTH	Torque -10°	Offset 8°	.022"
UL	MBUL1* + WBT2210LG		
UR	MBUR1* + WBT2210RG		

* aggiungere sempre la misura desiderata Es. MBUL1 25
* insert desired molar band size Ex. MBUL1 25



ROTH	Torque -25°	Offset 8°	.022"
LL	MBLL1* + WBT2225LG		
LR	MBLR1* + WBT2225RG		

* aggiungere sempre la misura desiderata Es. MBLL1 25
* insert desired molar band size Ex. MBLL1 25



EDGEWISE	Torque 0°	Offset 0°	.022"
UL	MBUL1* + WBT2200LG		
UR	MBUR1* + WBT2200RG		

* aggiungere sempre la misura desiderata Es. MBUL1 25
* insert desired molar band size Ex. MBUL1 25



EDGEWISE	Torque 0°	Offset 0°	.022"
LL	MBLL1* + WBT2200LG		
LR	MBLR1* + WBT2200RG		

* aggiungere sempre la misura desiderata Es. MBLL1 25
* insert desired molar band size Ex. MBLL1 25



RICKETTS	Torque -10°	Offset 8°	.018"
UL	MBUL1* + WBT3810LG		
UR	MBUR1* + WBT3810RG		

* aggiungere sempre la misura desiderata Es. MBUL1 25
* insert desired molar band size Ex. MBUL1 25



RICKETTS	Torque 0°	Offset 0°	.018"
LL	MBLL1* + WBT2800L		
LR	MBLR1* + WBT2800R		

* aggiungere sempre la misura desiderata Es. MBLL1 25
* insert desired molar band size Ex. MBLL1 25

■ Merce disponibile / Goods available
■ Merce a richiesta / Goods on request

Tubi da puntare non convertibili / Non-convertible weldable tubes

I Tubi sono prodotti con tecnologia MIM di altissima qualità in confezioni da 10 pezzi. Possono essere forniti singolarmente o saldati sulle bande.

High quality and precision tubes realized with MIM technology in box of 10pcs. They can be purchased loose or pre-welded to our bands.



Singolo / Single

	TORQUE	OFFSET	.018 x .025		.022 x .028	
			UR / LL	UL / LR	UR / LL	UL / LR
EDGEWISE	0°	0°	WBT1800R	WBT1800L	WBT1200R	WBT1200L
ROTH - UPPER	-10°	8°	WBT1810R	WBT1810L	WBT1210R	WBT1210L
ROTH - LOWER	-25°	8°	WBT1825R	WBT1825L	WBT1225R	WBT1225L
10 pcs / pack						



Doppio / Double .045 Occlusal

	TORQUE	OFFSET	.018 x .025		.022 x .028	
			UR / LL	UL / LR	UR / LL	UL / LR
ROTH - UPPER	-10°	8°	WBT2810RO	WBT2810LO	WBT2210RO	WBT2210LO
10 pcs / pack						



Doppio / Double .045 Gingival

	TORQUE	OFFSET	.018 x .025		.022 x .028	
			UR / LL	UL / LR	UR / LL	UL / LR
ROTH - UPPER	-10°	8°	WBT2810RG	WBT2810LG	WBT2210RG	WBT2210LG
ROTH - LOWER	-25°	8°	WBT2825LG	WBT2825RG	WBT2225LG	WBT2225RG
10 pcs / pack						



Doppio / Double Bioform

	TORQUE	OFFSET	.018 x .025		.022 x .028	
			LL	LR	LL	LR
RICKETTS - LOWER	0°	0°	WBT2800R	WBT2800L	-	-
10 pcs / pack						



Triplo / Triple .045 Gingival

	TORQUE	OFFSET	.018 x .025		.022 x .028	
			UR	UL	UR	UL
RICKETTS - UPPER	-10°	8°	WBT3810RG	WBT3810LG	-	-
10 pcs / pack						

■ Merce disponibile / Goods available

■ Merce a richiesta / Goods on request

Tubi da puntare convertibili / Convertible weldable tubes



Singolo / Single

	TORQUE	OFFSET	.018 x .025		.022 x .028	
			UR / LL	UL / LR	UR / LL	UL / LR
ROTH - UPPER	-10°	8°	WBT1810RC	WBT1810LC	WBT1210RC	WBT1210LC
ROTH - LOWER	-25°	8°	WBT1825LC	WBT1825RC	WBT1225LC	WBT1225RC
10 pcs / pack						



Singolo / Single

	TORQUE	OFFSET	.018 x .025		.022 x .028	
			LL	LR	LL	LR
MBT - LOWER	-20°	0°	CS1-816	CS1-815	CS1-216	CS1-215
10 pcs / pack						



Doppio / Double Auxiliary

	TORQUE	OFFSET	.018 x .025		.022 x .028	
			LL	LR	LL	LR
ROTH - LOWER	-25°	8°	WBT2825LC	WBT2825RC	WBT2225LC	WBT2225RC
10 pcs / pack						



Doppio / Double .045 Occlusal

	TORQUE	OFFSET	.018 x .025		.022 x .028	
			UR / LL	UL / LR	UR / LL	UL / LR
EDGEWISE	0°	8°	WBT2800RCO	WBT2800LCO	WBT2200RCO	WBT2200LCO
ROTH - UPPER	-10°	5°	WBT2810RCO	WBT2810LCO	WBT2210RCO	WBT2210LCO
10 pcs / pack						



Doppio / Double .045 Gingival

	TORQUE	OFFSET	.018 x .025		.022 x .028	
			LL	LR	LL	LR
ROTH - LOWER	-25°	8°	WBT2825LCG	WBT2825RCG	WBT2225LCG	WBT2225RCG
10 pcs / pack						



Doppio / Double .045 Gingival

	TORQUE	OFFSET	.018 x .025		.022 x .028	
			UR	UL	UR	UL
MBT - UPPER	-14°	10°	CC1-817	CC1-818	CC1-217	CC1-218
10 pcs / pack						



Tripla / Triple .045 Occlusal

	TORQUE	OFFSET	.018 x .025		.022 x .028	
			UR	UL	UR	UL
MBT - UPPER	-14°	10°	CT1-807	CT1-808	CT1-207	CT1-208
10 pcs / pack						



Tripla / Triple .045 Occlusal

	TORQUE	OFFSET	.018 x .025		.022 x .028	
			UR	UL	UR	UL
ROTH - LOWER	-10°	8°	WBT3810RCO	WBT3810LCO	WBT3210RCO	WBT3210LCO
10 pcs / pack						

■ Merce disponibile / Goods available

■ Merce a richiesta / Goods on request

Tubi mini da cementare 1° & 2° molare / 1° & 2° molar bondable mini tubes

Singolo non convertibile / Single non convertible



	TORQUE	OFFSET	.018 x .025		.022 x .028	
			UR / LL	UL / LR	UR / LL	UL / LR
EDGEWISE	0°	0°	61-711-11	61-711-21	61-712-11	61-712-21
ROTH - MAXILLARY	-10°	8°	61-721-11	61-721-21	61-722-11	61-722-21
ROTH - MANDIBULAR	-25°	5°	61-721-31	61-721-41	61-722-31	61-722-41
MBT - MAXILLARY	-14°	10°	61-731-11	61-731-21	61-732-11	61-732-21
MBT - MANDIBULAR	-20°	0°	61-731-31	61-731-41	61-732-31	61-732-41
10 pcs / pack						

Tubi da cementare non convertibili / Non-convertible bondable tubes

Prodotto di altissima qualità realizzato con tecnologia MIM, basetta ritentiva e con disegno anatomico, per adattarsi in maniera ottimale ai molari.

High quality product, manufactured with MIM technology. The bonding base is anatomically designed and contoured for positive adaptation to molars.



Singolo / Single

	TORQUE	OFFSET	.018 x .025		.022 x .028	
			UR / LL	UL / LR	UR / LL	UL / LR
EDGEWISE	0°	8°	BBT18008R	BBT18008L	BBT12008R	BBT12008L
ROTH - UPPER	-10°	8°	BBT18108R	BBT18108L	BBT1210R	BBT1210L
ROTH - LOWER	-25°	5°	BBT18255R	BBT18255L	BBT12255R	BBT12255L
MBT - UPPER	-14°	10°	-	-	BBT1410R	BBT1410L
MBT - LOWER	-20°	0°	-	-	BBT2000L	BBT2000R
10 pcs / pack						



Doppio / Double .045 Occlusal

	TORQUE	OFFSET	.018 x .025		.022 x .028	
			UR / LL	UL / LR	UR / LL	UL / LR
EDGEWISE	0°	8°	BBT28008OR	BBT28008OL	BBT22008OR	BBT22008OL
ROTH - UPPER	-10°	5°	BBT28108OR	BBT28108OL	BBT22108OR	BBT22108OL
10 pcs / pack						



Doppio / Double Bioform

	TORQUE	OFFSET	.018 x .025		.022 x .028	
			LL	LR	UR / LL	UL / LR
RICKETTS - LOWER	0°	0°	BBT2800R	BBT2800L	-	-
10 pcs / pack						

Tubi da cementare convertibili / Convertible bondable tubes



Singolo / Single

	TORQUE	OFFSET	.018 x .025		.022 x .028	
			UR / LL	UL / LR	UR / LL	UL / LR
ROTH - UPPER	-10°	8°	BBT18108RC	BBT18108LC	BBT12108RC	BBT12108LC
ROTH - LOWER	-25°	5°	BBT18255LC	BBT18255RC	BBT12255LC	BBT12255RC
10 pcs / pack						

Doppio / Double



	TORQUE	OFFSET	.018 x .025		.022 x .028	
			LL	LR	LL	LR
ROTH- LOWER	-25°	5°	BBT28255LC	BBT28255RC	BBT22255LC	BBT22255RC
10 pcs / pack						

Doppio / Double .045 Occlusal



	TORQUE	OFFSET	.018 x .025		.022 x .028	
			UR	UL	UR	UL
ROTH- LOWER	-10°	8°	BBT28108ORC	BBT28108OLC	BBT22108ORC	BBT22108OLC
10 pcs / pack						

Doppio / Double .045 Gingival



	TORQUE	OFFSET	.018 x .025		.022 x .028	
			UR	UL	UR	UL
ROTH - LOWER	-10°	8°	BBT28108GRC	BBT28108GLC	BBT22108GRC	BBT22108GLC
10 pcs / pack						

Doppio / Double .045 Gingival



	TORQUE	OFFSET	.018 x .025		.022 x .028	
			LL	LR	LL	LR
ROTH - LOWER	-25°	5°	BBT28255GLC	BBT28255GRC	BBT22255GLC	BBT22255GRC
10 pcs / pack						

Bande Molari TX / TX molar bands

Le bande anatomiche TX, sono realizzate con il migliore acciaio medicale ed hanno l'interno sabbiato, che ne garantisce un'ottima ritenzione ai cementi ortodontici. La marchiatura a laser permette una facile identificazione delle misure. Disponibili nelle misure da 29 a 44 per i molari mascellari e mandibolari. Disponibile inoltre un'eccellente servizio di prepuntatura.

Molar anatomical bands TX, made with the best medical steel. Size 29 to 44 for molar bands. Permanent laser identification markings and sandblasted for accurate cement adhesion. Dental World offers precision prepwelding of bands.

Kit Assortito / Assorted Kit

Bande Size	29.5	30	30.5	31	31.5	32	32.5	33	33.5	34	34.5	35	35.5	36	36.5	37	37.5	38	38.5	39	39.5	40	40.5	41	41.5	42	42.5	43	43.5	44
Trial Kit 80 pcs	-	-	-	-	-	2	2	4	4	4	6	6	10	10	10	6	6	4	4	2	-	-	-	-	-	-	-	-	-	-
Pro Kit 150 pcs	2	2	2	2	2	2	4	4	6	8	10	10	10	12	12	12	10	8	6	4	4	4	2	2	2	2	2	2	2	2
Master Kit 300 pcs	8	8	8	8	8	8	16	16	24	32	40	40	40	40	48	48	40	32	24	16	16	16	8	8	8	8	8	8	8	8

Kit Bande Molari / Molar Bands Kit

	Trial Kit 80 pcs.	Pro Kit 150 pcs.	Master Kit 300 pcs.
UPPER	KMBEU180	KMBEU1150	KMBEU1300
LOWER	KMBEL180	KMBEL1150	KMBEL1300



Bande Anatomiche TX / TX anatomical bands



UL	MBEUL1*
UR	MBEUR1*

* aggiungere sempre la misura desiderata Es. MBEUL1 29.5
* insert desired molar band size Ex. MBEUL1 29.5



LL	MBELL1*
LR	MBELR1*

* aggiungere sempre la misura desiderata Es. MBELL1 29.5
* insert desired molar band size Ex. MBELL1 29.5

Bande Prepuntate TX / TX prepwelded bands

Le bande TX possono essere prepuntate a scelta con i tubi sotto elencati, nelle varie tecniche. Per i kit e i ricambi, basta aggiungere alla fine del codice il riferimento del tubo scelto.

(Es. MBEUL129 + 64-611-12)

banda + doppio tubo

Bands can be prepwelded with tubes in different techniques. For kit and refills, add tube reference at the end of code

(Es. MBEUL129 + 64-611-12)

band + double tube



ROTH	Torque -10°	Offset 8°	.022"
UL	MBEUL1* + 64-622-22		
UR	MBEUR1* + 64-622-12		

* aggiungere sempre la misura desiderata Es. MBEUL1 29.5
* insert desired molar band size Ex. MBEUL1 29.5



ROTH	Torque -25°	Offset 5°	.022"
LL	MBELL1* + 64-622-32		
LR	MBELR1* + 64-622-42		

* aggiungere sempre la misura desiderata Es. MBELL1 29.5
* insert desired molar band size Ex. MBELL1 29.5



MBT	Torque -14°	Offset 10°	.022"
UL	MBEUL1* + 64-632-22		
UR	MBEUR1* + 64-632-12		

* aggiungere sempre la misura desiderata Es. MBEUL1 29.5
* insert desired molar band size Ex. MBEUL1 29.5



MBT	Torque -20°	Offset 0°	.022"
LL	MBELL1* + 64-632-32		
LR	MBELR1* + 64-632-42		

* aggiungere sempre la misura desiderata Es. MBELL1 29.5
* insert desired molar band size Ex. MBELL1 29.5

- Merce disponibile / Goods available
- Merce a richiesta / Goods on request

Tubi da puntare / Weldable tubes



Singolo non convertibile / Single non convertible

	TORQUE	OFFSET	.018 x .025		.022 x .028	
			UR / LL	UL / LR	UR / LL	UL / LR
EDGEWISE	0°	0°	63-611-11	63-611-21	63-612-11	63-612-21
ROTH - MAXILLARY	-10°	8°	63-621-11	63-621-21	63-622-11	63-622-21
ROTH - MANDIBULAR	-25°	5°	63-621-31	63-621-41	63-622-31	63-622-41
MBT - MAXILLARY	-14°	10°	63-631-11	63-631-21	63-632-11	63-632-21
MBT - MANDIBULAR	-20°	0°	63-631-31	63-631-41	63-632-31	63-632-41
10 pcs / pack						



Singolo convertibile / Single convertible

	TORQUE	OFFSET	.018 x .025		.022 x .028	
			UR / LL	UL / LR	UR / LL	UL / LR
ROTH - MAXILLARY	-10°	8°	64-621-11	64-621-21	64-622-11	64-622-21
ROTH - MANDIBULAR	-25°	5°	64-621-41	64-621-31	64-622-41	64-622-31
MBT - MAXILLARY	-14°	10°	64-631-11	64-631-21	64-632-11	64-632-21
MBT - MANDIBULAR	-20°	0°	64-631-41	64-631-31	64-632-41	64-632-31
10 pcs / pack						



Doppio convertibile / Double convertible .045 Gingival

	TORQUE	OFFSET	.018 x .025		.022 x .028	
			UR / LL	UL / LR	UR / LL	UL / LR
EDGEWISE	0°	0°	64-611-12	64-611-22	64-612-12	64-612-22
ROTH - MAXILLARY	-10°	8°	64-621-12	64-621-22	64-622-12	64-622-22
ROTH - MANDIBULAR	-25°	5°	64-621-32	64-621-42	64-622-32	64-622-42
MBT - MAXILLARY	-14°	10°	64-631-12	64-631-22	64-632-12	64-632-22
MBT - MANDIBULAR	-20°	0°	64-631-32	64-631-42	64-632-32	64-632-42
10 pcs / pack						



Triplo convertibile / Triple convertible .045 Occlusal

	TORQUE	OFFSET	.018 x .025		.022 x .028	
			UR / LL	UL / LR	UR / LL	UL / LR
ROTH - MAXILLARY	-10°	8°	64-621-13	64-621-23	64-622-13	64-622-23
MBT - MAXILLARY	-14°	10°	64-631-13	64-631-23	64-632-13	64-632-23
10 pcs / pack						

■ Merce disponibile / Goods available

■ Merce a richiesta / Goods on request

Tubi da cementare / Bondable tubes

Singolo non convertibile / Single non convertible



	TORQUE	OFFSET	.018 x .025		.022 x .028	
			UR / LL	UL / LR	UR / LL	UL / LR
EDGEWISE	0°	0°	61-611-11	61-611-21	61-612-11	61-612-21
ROTH - MAXILLARY	-10°	8°	61-621-11	61-621-21	61-622-11	61-622-21
ROTH - MANDIBULAR	-25°	5°	61-621-31	61-621-41	61-622-31	61-622-41
MBT - MAXILLARY	-14°	10°	61-631-11	61-631-21	61-632-11	61-632-21
MBT - MANDIBULAR	-20°	0°	61-631-31	61-631-41	61-632-31	61-632-41
10 pcs / pack						

Singolo non convertibile / Single non convertible



	TORQUE	OFFSET	.018 x .025		.022 x .028	
			UR / LL	UL / LR	UR / LL	UL / LR
EDGEWISE	0°	0°	61-611-11N	61-611-21N	61-612-11N	61-612-21N
ROTH - MAXILLARY	-10°	8°	61-621-11N	61-621-21N	61-622-11N	61-622-21N
ROTH - MANDIBULAR	-25°	5°	61-621-31N	61-621-41N	61-622-31N	61-622-41N
MBT - MAXILLARY	-14°	10°	61-631-11N	61-631-21N	61-632-11N	61-632-21N
MBT - MANDIBULAR	-20°	0°	61-631-31N	61-631-41N	61-632-31N	61-632-41N
10 pcs / pack						

Singolo convertibile / Single convertible



	TORQUE	OFFSET	.018 x .025		.022 x .028	
			UR / LL	UL / LR	UR / LL	UL / LR
EDGEWISE	0°	0°	62-611-11	62-611-21	62-612-11	62-612-21
ROTH - MAXILLARY	-10°	8°	62-621-11	62-621-21	62-622-11	62-622-21
ROTH - MANDIBULAR	-25°	5°	62-621-31	62-621-41	62-622-31	62-622-41
MBT - MAXILLARY	-14°	10°	62-631-11	62-631-21	62-632-11	62-632-21
MBT - MANDIBULAR	-20°	0°	62-631-31	62-631-41	62-632-31	62-632-41
10 pcs / pack						

Singolo da cementare low nickel / Single low nickel bondable



	TORQUE	OFFSET	.022 x .028	
			UR / LR	UL / LL
MBT	14°	8°	MXBM122-16	MXBM122-26
MBT	20°	0°	MXBM122-46	MXBM122-36
ROTH	-14°	10°	MXBR122-16	MXBR122-26
ROTH	-25°	4°	MXBR122-46	MXBR122-36
10 pcs / pack				



Doppio convertibile / Double convertible .045 Gingival

	TORQUE	OFFSET	.018 x .025		.022 x .028	
			UR / LL	UL / LR	UR / LL	UL / LR
EDGEWISE	0°	0°	62-611-12	62-611-22	62-612-12	62-612-22
ROTH - MAXILLARY	-10°	8°	62-621-12	62-621-22	62-622-12	62-622-22
ROTH - MANDIBULAR	-25°	5°	62-621-32	62-621-42	62-622-32	62-622-42
MBT - MAXILLARY	-14°	10°	62-631-12	62-631-22	62-632-12	62-632-22
MBT - MANDIBULAR	-20°	0°	62-631-32	62-631-42	62-632-32	62-632-42
10 pcs / pack						



Triplo convertibile / Triple convertible .045 Occlusal

	TORQUE	OFFSET	.018 x .025		.022 x .028	
			UR / LL	UL / LR	UR / LL	UL / LR
ROTH - MAXILLARY	-10°	8°	62-621-13	62-621-23	62-622-13	62-622-23
MBT - MAXILLARY	-14°	10°	62-631-13	62-631-23	62-632-13	62-632-23
10 pcs / pack						

Lingual sheaths

Realizzati per accettare Barre Palatali, Quad Helix o altri format removibili con diametri fino a .036" x .072". Devono essere assicurati con una legatura metallica o elastica per evitare che vengano ingeriti.

Designed to accept palatal bars, Quad Helix appliances and other removable appliances incorporating .036" x .072" distal engagement ends. To be locked with metal or elastomeric ligature ties to avoid its ingestion.

Con gancio / With Hook

Lingual Sheaths Left	WLS055L
Lingual Sheaths Right	WLS055R
10 pcs / pack	

Lingual Sheaths LEFT
WLS055L

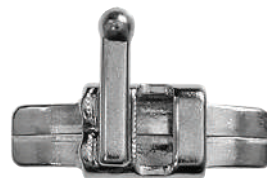

Lingual Sheaths RIGHT
WLS055R

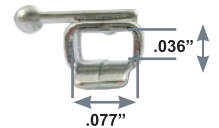
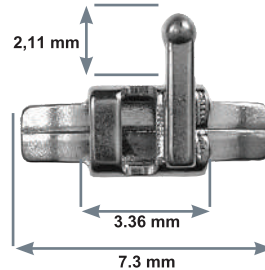

Senza gancio / Without Hook

Lingual Sheaths Universal	WLS155
10 pcs / pack	

Lingual Sheaths UNIVERSAL
WLS155



Cleat Linguale / Lingual Cleat

Ideali per agganciare legature metalliche o elastiche.
Ideal for metal and elastomeric ligatures.

Lingual Cleat Short	WLCSHORT
Lingual Cleat Long	WLCLONG
10 pcs / pack	

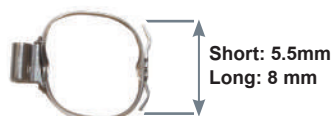

■ Merce disponibile / Goods available
■ Merce a richiesta / Goods on request

Impianti ortodontici / *Orthodontic implants*

OrthAnchor

Gli OrthAnchor sono impianti ortodontici progettati per fornire un ancoraggio stabile e sicuro durante i trattamenti ortodontici. Realizzati in lega di titanio ad alta resistenza, questi dispositivi offrono una straordinaria resistenza alla frattura, migliorata del 15-30% rispetto alla concorrenza. Gli OrthAnchor sono dotati di una punta affilata che consente un inserimento rapido e scorrevole di un design affusolato che garantisce una stabilità ottimale dell'ancoraggio sin dalle prime fasi dell'intervento.

OrthAnchor are orthodontic implants designed to provide a stable and secure anchorage during orthodontic treatments. Made of high-strength titanium alloy, these devices offer outstanding fracture resistance, improved by 15-30% over the competition. OrthAnchors feature a sharp tip that allows for quick and smooth insertion and a tapered design that provides optimal anchorage stability from the early stages of the procedure.

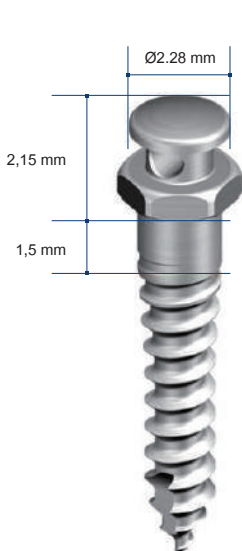

	6 mm	8 mm	10 mm
Ø1,2 mm	Ø1,2x6	-	-
Ø1,4 mm	Ø1,4x6	Ø1,4x8	-
Ø1,6 mm	Ø1,6x6	Ø1,6x8	Ø1,6x10
Ø1,8 mm	Ø1,8x6	Ø1,8x8	Ø1,8x10

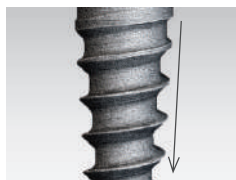

Gli OrthAnchor sono dotati di una punta affilata che consente un inserimento rapido e scorrevole di un design affusolato che garantisce una stabilità ottimale dell'ancoraggio sin dalle prime fasi dell'intervento.

OrthAnchors feature a sharp tip that allows for quick and smooth insertion and a tapered design that provides optimal anchorage stability from the early stages of the procedure.

OrthAnchor - Foro passante / *OrthAnchor - Through Hole*

- Il foro può essere legato con fili (.022");
The hole can be ligated with wires (.022");
- Testa progettata per una facile legatura con fili, catenelle o molle.
Head designed for easy ligate with wire, chain or springs.

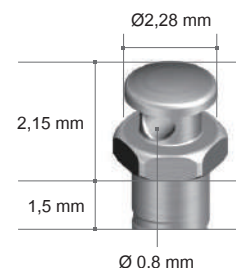

OrthAnchor - Testa bracket / *OrthAnchor - Bracket Head*

Gli OrthAnchor sono dotati di una punta affilata che consente un inserimento rapido e scorrevole di un design affusolato che garantisce una stabilità ottimale dell'ancoraggio sin dalle prime fasi dell'intervento.

OrthAnchors feature a sharp tip that allows for quick and smooth insertion and a tapered design that provides optimal anchorage stability from the early stages of the procedure.

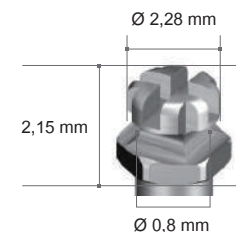
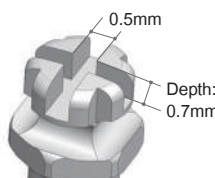

■ Merce disponibile / *Goods available*

■ Merce a richiesta / *Goods on request*

OrthAnchor - Foro passante / OrthAnchor - Through Hole

	LUNGHEZZA / LENGHT (L)		
	6 mm	8 mm	10 mm
Ø1,2 mm - G/H 1,5 mm	OSTH1206	OSTH1208	-
Ø1,4 mm - G/H 1,5 mm	OSTH1406	OSTH1408	-
Ø1,6 mm - G/H 1,5 mm	OSTH1606	OSTH1608	OSTH1610
Ø1,6 mm - G/H 4,0 mm	OSTH16064	-	-
Ø1,8 mm - G/H 1,5 mm	OSTH1806	OSTH1808	OSTH1810
Ø1,8 mm - G/H 4,0 mm	OSTH18064	-	-
1 pc / pack			

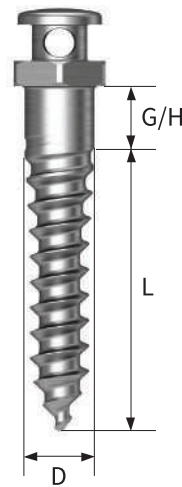

OSSTEM[®]
IMPLANT

OrthAnchor - Testa bracket / OrthAnchor - Bracket Head

	LUNGHEZZA / LENGHT (L)		
	6 mm	8 mm	10 mm
Ø1,4 mm - G/H 1,5 mm	OSBH1406	OSBH1408	-
Ø1,6 mm - G/H 1,5 mm	OSBH1606	OSBH1608	OSBH1610
Ø1,8 mm - G/H 1,5 mm	OSBH1806	OSBH1808	OSBH1810
1 pc / pack			

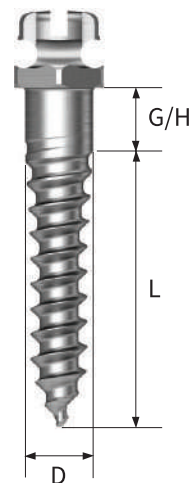

OSSTEM[®]
IMPLANT

Ortho KIT

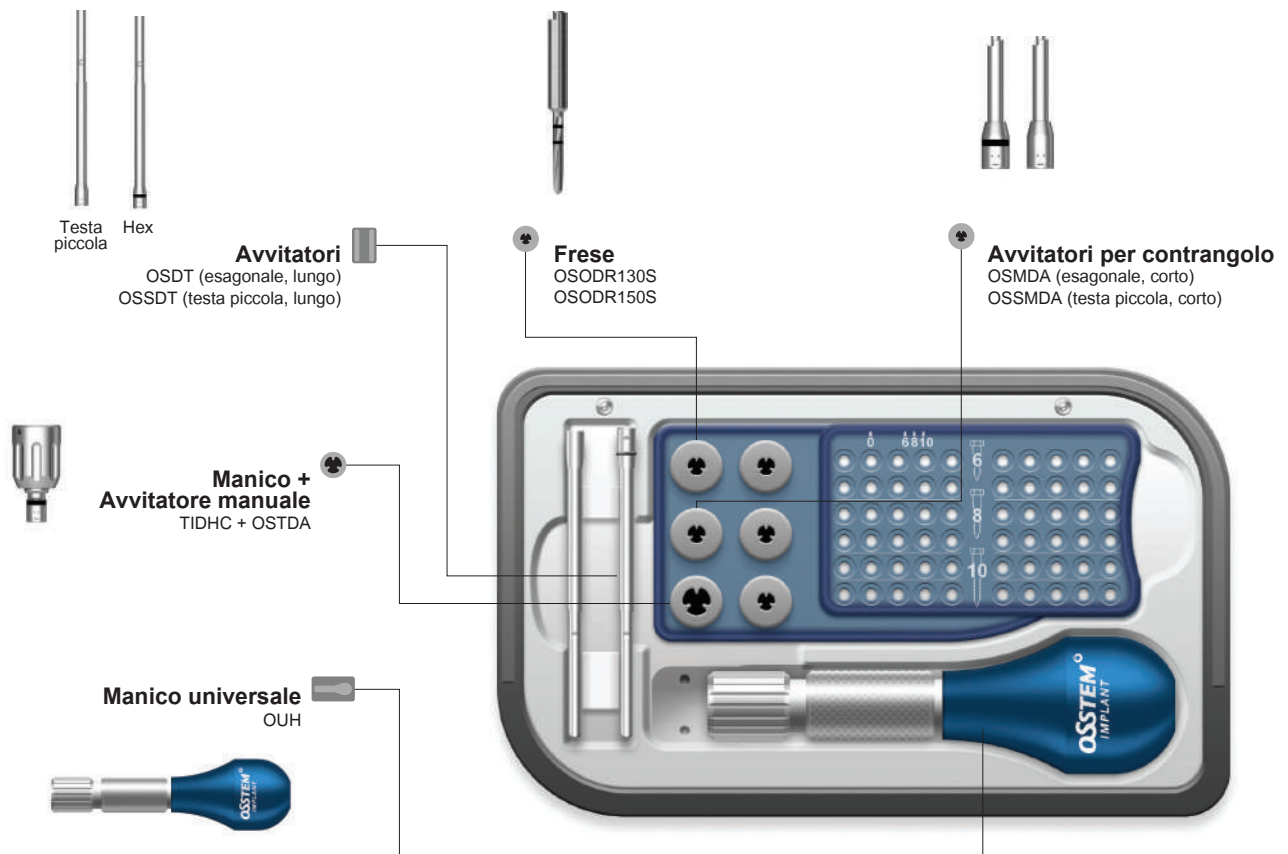

Ortho KIT **OOKS**

Frese / Drills

- Utilizzare la fresa collegandola al manipolo. (motore);
Use drill by connecting with handpiece. (engine);
- Fresa Ø1,0 mm: utilizzare prima dell'inserimento della vite Ø1,2/1,4 mm;
Ø1.0 mm drill: use before Ø1.2/1.4 mm screw insertion;
- Fresa Ø1,3 mm: utilizzare prima dell'inserimento della vite Ø1,6 mm;
Ø1.3 mm drill: use before Ø1.6 mm screw insertion;
- Fresa Ø1,5 mm: utilizzare prima dell'inserimento della vite Ø1,8 mm;
Ø1.5 mm drill: use before Ø1.8 mm screw insertion;
- Velocità consigliata della fresa: 800 giri/min. (alta velocità);
Recommend speed of drill: 800 rpm. (high speed);
- Prima di inserire le viti, si consiglia di eliminare solo l'osso corticale. (se l'osso corticale è molto spesso, perforare la stessa lunghezza delle viti);
Before screw insertion recommend to the eliminated cortical bone only. (if the cortical bone were very thick, drilling equal length as screws);
- La fresa da Ø1,0 mm non è inclusa nel kit.
Ø1.0 mm drill is not included in the kit.

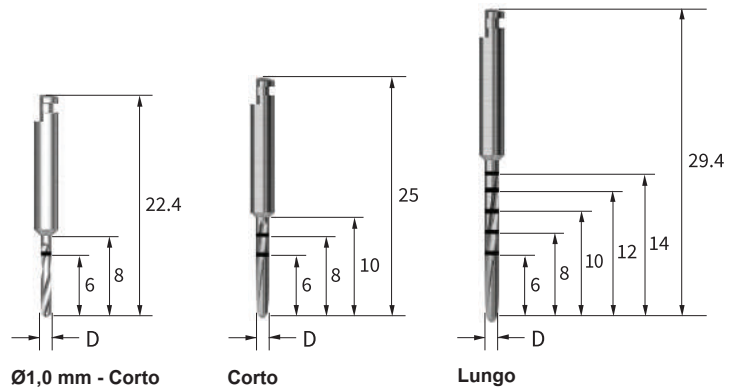

	Ø1,0 mm	Ø1,3 mm	Ø1,5 mm
Corto	OSODR100S	OSODR130S	OSODR150S
Lungo	-	OSODR130C	OSODR150C

■ Merce disponibile / Goods available
■ Merce a richiesta / Goods on request

Manico Universale / *Universal handle*



Universal handle | **OUH**

- Il manico universale può essere utilizzato collegandolo alla punta del driver per l'inserimento delle viti;
The universal handle can be used by connecting with the driver tip to screw insertion;
- L'impugnatura incisa favorisce l'inserimento manuale.
The scribed grip to support manual insertion.

Avvitatori / *Driver tip*

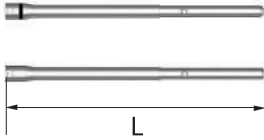

	Hex	Testa piccola
Corto	OSDTS(45)	OSSDTS(45)
Lungo	OSDT(67)	OSSDT(67)

- Il manico universale può essere utilizzato collegandolo alla punta del driver per l'inserimento delle viti;
The universal handle can be used by connecting with the driver tip to screw insertion;
- L'impugnatura incisa favorisce l'inserimento manuale.
The scribed grip to support manual insertion.

Impugnatura del driver / *Driver handle*



Driver handle | **TIDHC**

- L'impugnatura serve per l'inserimento delle viti tramite il collegamento con un driver manuale.
Driver handle use to screw insertion by connecting with a hand driver.

Avvitatore manuale / *Hand driver*



Hex



Testa piccola / *Small head*

Hex	Testa piccola
OSTDA	OSSTDA

- Driver manuale progettato per l'inserimento di viti mediante collegamento con l'impugnatura del driver o la chiave a cricchetto;
Hand driver designed to screw insertion by connecting with Driver handle or ratchet wrench;
- Due tipi di avvitatore manuale per utilizzare le diverse dimensioni della testa della vite;
Two types of hand driver to use different size of the screw head;
- Avvitatore esagonale per la testa della vite di dimensioni normali, e avvitatore piccolo per la testa della vite di dimensioni ridotte;
Hex driver for normal size of the screw head, and small driver for the small size of the screw head;
- L'avvitatore manuale a testa piccola non è incluso nel kit.
Small head hand driver is not included in the Kit.

Avvitatore per contrangolo / *Machine driver*



Hex



- Avvitatori per contrangolo progettati per l'inserimento di viti tramite il collegamento con il motore;
Machine driver designed to screw insertion by connecting with engine;
- Due tipi di avvitatore manuale per utilizzare le diverse dimensioni della testa della vite;
Two types of hand driver to use different size of the screw head;
- Avvitatore esagonale per la testa della vite di dimensioni normali, e avvitatore piccolo per la testa della vite di dimensioni ridotte;
Hex Machine driver for normal size of the screw head;
- Avvitatore per contrangoli esagonale per viti con testa di dimensioni normali.
Small head Machine driver for the small size of the screw head.

	Hex	Testa piccola
Corto	OSMDA(21.4)	OSSMDA(21.4)
Lungo	OSMDB(31.4)	OSSMDB(31.4)

■ Merce disponibile / *Goods available*
■ Merce a richiesta / *Goods on request*

PRO FLEX

n.h.a.

Flessibile
SICURO
Resistente

Adesivi / Bonding

Extreme Foto Ortho

Composito fotopolimerizzante con sistema adesivo per attacchi in metallo, ceramica e resina. Il composito ha una fluidità che elimina il problema della fluttuazione dell'attacco.

Light curing composite for metal, ceramic and resin brackets bonding system. It flows well and eliminates the bracket flotation.

Confezione / Packaging:

Kit

- 4 siringhe x 5 g / 5 g x 4 syringes each
- 7 ml adesivo fotopolimerizzante / 7 ml light curing bonding
- 7 ml acido ortofosforico 37% / 7 ml orthophosphoric acid 37%
- Blocco per impasto / Mixing pad
- Pennellini / Brushes
- Spatola / Spatula
- IFU

Ricambio / Refill

- 1 siringa x 5 g / 5 g x 1 syringe
- 7 ml adesivo fotopolimerizzante / 7 ml light curing bonding
- 7 ml acido ortofosforico 37% / 7 ml orthophosphoric acid 37%



Kit

Extreme Foto Ortho Kit	0004100
------------------------	---------

Ricambio / Refill

Extreme Foto Ortho - 5g x 1 syringe	0004103
Extreme Foto Ortho - 7ml light curing bonding - 1pc	0004104
Extreme Foto Ortho - 7ml orthophosphoric acid 37% - 1pc	0004106

A rilascio di Fluoro
Contains fluoride

Extreme Foto G.I.

Composito fotopolimerizzante indicato per la cementazione di bande ed altre applicazioni ortodontiche (tipo rialzi). Molto resistente, si lega chimicamente allo smalto e ai metalli. Colore blu.

Light curing composite recommended for bands cementing and other orthodontic appliance. Excellent resistance, it chemically bonds to enamel and metals. Blue colour.

Confezione / Packaging:

Kit

- 4 siringhe x 5 g / 5 g x 4 syringes each
- Blocco per impasto / Mixing pad
- Spatola / Spatula
- IFU

Ricambio / Refill

- 1 siringa x 5 g / 5 g x 1 syringe



A rilascio di Fluoro
Contains fluoride

Kit

Extreme Foto G.I. Kit	0004130
-----------------------	---------

Ricambio / Refill

Extreme Foto G.I.- 5g x 1 syringe	0004132
-----------------------------------	---------

■ Merce disponibile / Goods available

■ Merce a richiesta / Goods on request

Ortho Flow fotopolimerizzante / Light curing Ortho Flow

Ortho Flow è un composito fotopolimerizzante per il bonding diretto di brackets in metallo o ceramica; particolarmente indicato anche per retainers. Questo prodotto non necessita dell'applicazione dell'adesivo sulla superficie dello smalto, riducendo così notevolmente i tempi alla poltrona.

Light Curing composite for ceramic and metal brackets bonding, also indicated for retainers. Ortho Flow doesn't require any bonding agent on enamel surface, reducing patient treatment time.

Confezione / Packaging:

Kit

- 4 siringhe x 2 g / 2 g x 4 syringes each
- Aghetti / Tips

Ricambio / Refill

- 1 siringa x 2 g / 2 g x 1 syringe
- Aghetti / Tips

Refill



Kit



Ortho Flow

Ortho Flow - Kit	00340144
Ortho Flow - Refill	00340174

Ortho Flow Plus fotopolimerizzante / Light curing Ortho Flow Plus

L'evoluzione del composito fluido fotopolimerizzante Ortho Flow, si chiama Ortho Flow Plus, specifico per ortodonzia permette il bandaggio diretto di bracket in metallo, ceramica e resina, senza l'applicazione dell'adesivo ma solo previa mordenzatura dello smalto.

The evolution of the light-curing flowable composite Ortho Flow, it is called Ortho Flow Plus, specifically for orthodontics allows direct banding of metal, ceramic and resin brackets without adhesive application but only after enamel etching.

Confezione / Packaging:

Kit

- 3 siringhe x 3 g / 3 g x 3 syringes each
- 1 siringa da 4 g CreaFILL Get Etch Bio
1 x 4 g syringe CreaFILL Get Etch Bio
- Aghetti / Tips
- IFU

Refill

- 1 siringa da 3 g / 1 x 3 g syringe
- Aghetti / Tips
- IFU

Ortho Flow Plus

Ortho Flow Plus - Kit	9000982
Ortho Flow Plus - Refill	9000981

Kit



Refill



NEW VERSION

- Merce disponibile / Goods available
- Merce a richiesta / Goods on request

Over Etch acido ortofosforico 35% / 35% phosphoric acid

Over Etch (Acido ortofosforico al 35%) è un condizionatore smalto dentinale con una particolare viscosità ed una appropriata tissotropia. Over Etch è stato progettato per non causare alcun inconveniente durante la fase di mordenzatura, consentendone il posizionamento in maniera non invasiva, in qualsiasi punto, grazie alla sua particolare consistenza non gelatinosa.

Over Etch (35% Phosphoric acid) is a dental etching agent of viscous solution type, with thixotropic properties. Over Etch is designed to have a minimal cloggy effect during etching and to easily get all areas, thanks to its non-gelatinous texture.

Confezione / Packaging:

Kit

- 4 siringhe x 1,2 ml / 1,2 ml x 4 syringes each
- Aghetti / Tips
- IFU

Siringone / Big Bulk

- 1 siringone x 30 ml / 30 ml x 1 big bulk
- 1 siringa vuota / 1 empty syringe
- Aghetti / Tips
- IFU

Over Etch

Over Etch - Kit	0000173
Over Etch - Big Bulk	0000172



Extreme One-Step

One Step Composito **autopolimerizzante** per attacchi in metallo e ceramica. Il composito, altamente riempitivo, ha una viscosità e fluidità che elimina il problema della fluttuazione dell'attacco. La catalizzazione del composito avviene per contatto, garantisce 40 secondi per il posizionamento e indurisce completamente entro 5 minuti.

Self-Curing composite for bonding metal and ceramic brackets. It has a viscosity and fluidity that eliminate brackets flotation. The catalyst system sets on contact and gets maximum strength within five minutes.

Confezione / Packaging:

Kit Siringhe / Syringes Kit

- 4 siringhe x 5 g / 5 g x 4 syringes each
- 12 ml primer / 12 ml primer
- 7 ml acido ortofosforico 37% / 7 ml orthophosphoric acid 37%
- Blocco per impasto / Mixing pad
- Pennellini / Brushes
- Spatola / Spatula
- IFU

Kit Siringhe / Syringes Kit



Kit Capsule / Compules Kit

- Pasta 14 g (0.35g x 40 capsule) / 14 g paste (0.35 g x 40 compules)
- 12 ml primer / 12 ml primer
- 7 ml acido ortofosforico 37% / 7 ml orthophosphoric acid 37%
- Blocco per impasto / Mixing pad
- Dispenser / Dispenser
- Spatola / Spatula
- IFU

Ricambio / Refill

- 1 siringa x 5 g / 5 g x 1 syringe
- Pasta 14 g (0.35g x 40 capsule) / 14 g paste (0.35 g x 40 compules)
- 12 ml primer / 12 ml primer
- 7 ml acido ortofosforico 37% / 7 ml orthophosphoric acid 37%

Kit Capsule / Compules Kit

Ricambi / Refill



Capsule / Compules



Acido ortofosforico 37%
orthophosphoric acid 37%



Primer



Kit

Extreme One-Step Kit - SYRINGES	0004110
Extreme One-Step Kit - COMPULES	0004112

Ricambio / Refill

Extreme One-Step - 5g x 1 syringe	0004113
Extreme One-Step - Compules - 40 pcs	0004115
Extreme One-Step - Primer 12 ml - 1 pc	0004114
Extreme One-Step - 7ml orthophosphoric acid 37% - 1pc	0004106

■ Merce disponibile / Goods available

■ Merce a richiesta / Goods on request

Extreme One-Step G.I.

Cemento vetroionomerico progettato per la cementazione di applicazioni ortodontiche.

Glass ionomer cement designed for the cementation of orthodontic applications.

Confezione / Packaging:

Kit

- 18 ml polvere / Powder 18 ml
- 17.5 ml liquido / Liquid 17.5 ml
- Blocco per impasto / Mixing pad
- Misurino / Measuring
- IFU

Ricambio / Refill

- 18 g polvere / Powder 18 g
- 17.5 g liquido / Liquid 17.5 g



A rilascio di Fluoro
Contains fluoride

Kit

Extreme One-Step G.I. Kit	0004140
---------------------------	----------------

Ricambio / Refill

Extreme One-Step G.I. - 18 ml Powder	0004141
Extreme One-Step G.I. - 17.5 ml Liquid	0004142

Extreme Ortho Glass L.C.

Cemento vetroionomerico fotopolimerizzabile progettato per la cementazione di applicazioni ortodontiche.

Glass ionomer light-curing cement designed for the cementation of orthodontic applications.

Confezione / Packaging:

Kit

- 15 g polvere / Powder 15 g
- 6.8 ml liquido / Liquid 6.8 ml
- Blocco per impasto / Mixing pad
- Misurino / Measuring
- IFU



Extreme Ortho Glass L.C. Kit	0004151
------------------------------	----------------

■ Merce disponibile / Goods available

■ Merce a richiesta / Goods on request

Fili e Tubi elastici / *Elastomeric wires and tubes*

Fili e tubi elastici progettati per massimizzare la funzionalità del prodotto e l'efficienza del trattamento ortodontico; sono realizzati in materiali di grado medicale superiore.

Medical grade elastomers, designed to highten the product functionality and the efficiency of the orthodontic treatment.

Filo Liscio



Lunghezza / *Length* 50' (15,24m)

Elastic Thread-Solid

	Ø.25"	Ø.30"
Grey	ETGY025	ETGY030
Clear	ETCL025	ETCL030
1 pc / pack		

Tubo Elastico



Lunghezza / *Length* 50' (15,24m)

Elastic Thread-Hollow

	Ø.25"	Ø.30"
Grey	TBGY025	TBGY030
Clear	TBCL025	TBCL030
1 pc / pack		

Filo Ruvido



Lunghezza / *Length* 25' (7,62m)

Slip-Not Thread-Solid

	Ø.25"	Ø.30"
Grey	SNTGY025	SNTGY030
Clear	SNTCL025	SNTCL030
1 pc / pack		

Fulcro di rotazione / *Rotation wedge*

Il fulcro di rotazione è un accessorio indispensabile per amministrare forze e rotazioni, là dove lo si desidera.

Rotation wedge, indispensable to manage rotation forces where desired.

Rotation wedge

Grey	RWPGY100
Clear	RWPCL100
100 pcs / pack	



Separatori elastici / *Elastomeric separators*

Separatori radiopachi impiegati prima dell'inserimento delle bande.

Radiopaque separators used before band insertion.

Separatori radiopachi / *Radiopaque separators*



Blue	ROSP1000
1000 pcs / pack	

Separatori elastici / *Elastomeric separators*

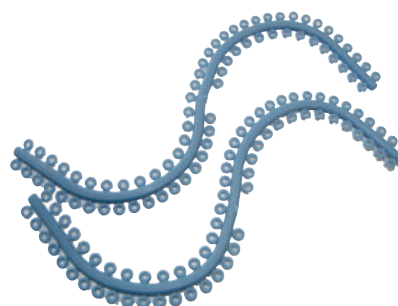

Blue	(54)044-01
1000 pcs / pack	

■ Merce disponibile / *Goods available*

■ Merce richiesta / *Goods on request*

Catenelle elastiche / *Elastomeric chains*

Le catenelle elastiche hanno caratteristiche di precisione, memoria e stabilità del colore eccellenti, rispetto alle catenelle tradizionali. Disponibili in 32 colori diversi a scelta.

Elastomeric chains offer superior memory and precision with excellent colour stability. Available in 32 different colours.

PEARL PL	GLOW GW	NEON GREEN NG	PEARL GREEN PG	GLOW BLUE GB	PEARL BLUE PB	LAVENDER LV	MAROON MA
CLEAR CL	DARK GREY GY	MET. SILVER SV	MET. GOLD GD	MET. PURPLE PP	MET. RED MR	MET. BLUE MB	ROYAL BLUE RB
LT. SKY BLUE LS	DEEP SKY BLUE DS	NAVY BLUE NB	GREEN GR	TRANS. GREEN TG	RUBY RED RR	TURQUOISE TQ	WHITE WT
MIXED AS	FUCHSIA FU	BLACK BK	ORANGE OR	YELLOW YW	HOT PINK PK	TOOTH TC	SMOKE SM



.026" thickness

Continuous	Short	Long
CDL**	SDL**	LDL**
15 ft. spool (4,57 mt.)		



SLIM .018" thickness

	Continuous	Short	Long
Clear	CDLCLT	SDLCLT	LDLCLT
Grey	CDLSVT	SDLSVT	LDLSVT
15 ft. spool (4,57 mt.)			

Catenelle elastiche / *Elastomeric chains*

Realizzate in materiale di ottima qualità, garantiscono una lunga durata nel tempo, sia nella stabilità del colore, che nella resistenza alle macchie.

Made with high quality material, Eclipse chains grant long time durability and colour stability.



.026" thickness

	Continuous	Short	Long
Clear	(52)003-01	(52)002-01	(52)001-01
Grey	(52)003-02	(52)002-02	(52)001-02
Light Pink	(52)003-03	(52)002-03	(52)001-03
Green Lime	(52)003-06	(52)002-06	(52)001-06
Bordeaux	(52)003-11	(52)002-11	(52)001-11
Pink Bubble	(52)003-13	(52)002-13	(52)001-13
Aqua	(52)003-17	(52)002-17	(52)001-17
Metal Purple	(52)003-29	(52)002-29	(52)001-29
15 ft. spool (4,57 mt.)			



- Merce disponibile / Goods available
- Merce a richiesta / Goods on request

Legature elastiche / *Elastomeric ligature Ties*



Nuova linea di legature OverTie Select made in Italy, dall'eccellente capacità elastica, realizzate con materiale ad altissima resa elastica usando il metodo ad iniezione e stampi di precisione. Utilizzate nel campo dell'ortodonzia per facilitare la legatura del filo o dell'arco ortodontico ai brackets. Il diametro delle legature è di Ø 120. Disponibili in diverse colorazioni.

New line of OverTie Select ligatures made in Italy, with excellent elastic capacity, made from material with very high elastic performance using the injection method and precision molds. Used in the field of orthodontics to facilitate ligation of the orthodontic arch to brackets. The diameter of the ligatures is Ø 120. Available in different colors.

OverTie Select ligatures ties

Assorted	AA01310W	Neon yellow	AA01346W
Silver	AA01336W	Mustard	AA01347W
Clear	AA01337W	Neon orange	AA01348W
Light pink	AA01338W	Neon fuchsia	AA01349W
Lime green	AA01339W	Fuchsia	AA01350W
Night blue	AA01340W	Violet	AA01351W
Orange	AA01341W	Light blue	AA01352W
Ice blue	AA01342W	Neon green	AA01353W
Yellow	AA01343W	Green	AA01354W
Red	AA01344W	Neon light blue	AA01355W
White	AA01345W	Black	AA01356W
26 ties for 40 sticks			





Legature elastiche / *Elastomeric ligature Ties*

Legature elastiche, dotate di una eccellente capacità elastica; prodotte con un ottimo elastomero per garantire prestazioni di lunga durata. Sono disponibili nei classici colori: trasparente e grigio. Il diametro delle legature è Ø 120.

Excellent elastomeric property, for long time durability. Clear and Grey. Diameter Ø 120.

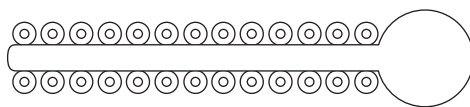
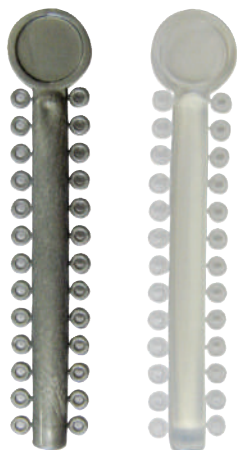

Dimensione reale / *Illustration actual size*



Eclipse ligatures ties

Silver	(51)AA01326
Clear	(51)AA01327
Light Pink	(51)AA01328
Green Lime	(51)AA01329
Metal Blue	(51)AA01330
Orange	(51)AA01331
Light Blue	(51)AA01332
Yellow	(51)AA01333
Red	(51)AA01334
Assorted	(51)AA01300
26 ties for 40 sticks	

ASSORTED 00	CLEAR 27	SILVER 26	LIGHT PINK 28	GREEN LIME 29
RED 34	LIGHT BLUE 32	MET. BLUE 30	ORANGE 31	YELLOW 33

■ Merce disponibile / *Goods available*

■ Merce a richiesta / *Goods on request*

Legature elastiche / *Elastomeric ligature Ties*

Legature Ortho World, realizzate con un polimero di grado medicale privo di lattice; confezionate in buste da 46 sticks, da 22 legature. Il design si caratterizza per la forma arrotondata, che rende la legatura estremamente confortevole. E' un prodotto che non assorbe macchie e non sbiadisce nel tempo. Il diametro delle legature è Ø 120.

Made with a latex-free medical polymer; packed in 46 sticks/bag - 22 ties per stick. Round design for extreme comfort.

They don't absorb stains and don't bleach over the time. Diameter Ø 120.

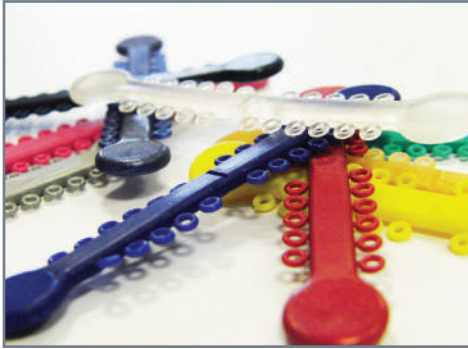

ORTHOWORLD
LIGATURE TIES

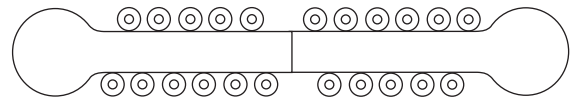

Dimensione reale / *Illustration actual size*

PEARL PL	GLOW GW	NEON GREEN NG	PEARL GREEN PG	GLOW BLUE GB	PEARL BLUE PB	LAVENDER LV	MAROON MA
CLEAR CL	DARK GREY GY	MET. SILVER SV	MET. GOLD GD	MET. PURPLE PP	MET. RED MR	MET. BLUE MB	ROYAL BLUE RB
LT. SKY BLUE LS	DEEP SKY BLUE DS	NAVY BLUE NB	GREEN GR	TRANS. GREEN TG	RUBY RED RR	TURQUOISE TQ	WHITE WT
MIXED AS	FUCHSIA FU	BLACK BK	ORANGE OR	YELLOW YW	HOT PINK PK	TOOTH TC	SMOKE SM

SENSITIVE
LATEX
FREE
PATIENTS

Elastomeric Ligatures

VT ** 46

22 ties for 46 sticks

** Indicano il colore / *add colour code*

Ex. "CLEAR Ligature": VTCL46

Legature elastiche precaricate / *Pre-loaded ligatures*

Legature elastiche precaricate, possono essere sostituite alle legature metalliche.

Pre-loaded elastic ligatures may replace metal ligatures.

Pre-loaded ligatures

Ø 120	Ø 120
Clear	CCL20
Grey	CGY20
1000 pcs / pack	



■ Merce disponibile / *Goods available*

■ Merce a richiesta / *Goods on request*

Elastici Intraorali - Extraorali / *Intraoral - Extraoral latex elastics*

Gli elastici intraorali, sono prodotti in puro lattice di grado medicale. Garantiscono un'alta elasticità ed assicurano forze precise e costanti. Confezionati in bustine di differenti colorazioni per un'immediata identificazione del diametro. La forza viene contraddistinta mediante un'immagine e un nome. Sono fornibili in un dispenser da 50 bustine o in confezioni da 10 bustine.

Manufactured from the finest medical grade latex to ensure reliable force delivery. For an immediate identification, each diameter has an identification colour on the bag, while size and force are identifiable with a picture and a name. Available in box with 50 bags or 10 bags.

Elastici Intraorali / *Intraoral elastics* 1 bag = 50 pcs

1/8" (3,18mm) Orange Bag

	Oz (g)	Figures	5000 pcs	1000 pcs
Light	2.5 oz (70,88g)	<i>Leprechaun</i>	18LTAM	18LTAM-10
Medium	4.5 oz (127,58g)	<i>Dragon</i>	18MDAM	18MDAM-10
Heavy	6.5 oz (184,28g)	<i>Wizard</i>	18HVAM	18HVAM-10

3/16" (4,77mm) Blue Bag

	Oz (g)	Figures	5000 pcs	1000 pcs
Light	2.5 oz (70,88g)	<i>Frog Prince</i>	36LTAM	36LTAM-10
Medium	4.5 oz (127,58g)	<i>Genie</i>	36MDAM	36MDAM-10
Heavy	6.5 oz (184,28g)	<i>Unicorn</i>	36HVAM	36HVAM-10
Extra Heavy	8.5 oz (240,98g)	<i>Gnome</i>	36XHAM	36XHAM-10

1/4" (6,35mm) Green Bag

	Oz (g)	Figures	5000 pcs	1000 pcs
Light	2.5 oz (70,88g)	<i>Giant</i>	14LTAM	14LTAM-10
Medium	4.5 oz (127,58g)	<i>Sprite</i>	14MDAM	14MDAM-10
Heavy	6.5 oz (184,28g)	<i>Pegasus</i>	14HVAM	14HVAM-10
Extra Heavy	8.5 oz (240,98g)	<i>Minotaur</i>	14XHAM	14XHAM-10

5/16" (7,95mm) Red Bag

	Oz (g)	Figures	5000 pcs	1000 pcs
Light	2.5 oz (70,88g)	<i>Centaur</i>	56LTAM	56LTAM-10
Medium	4.5 oz (127,58g)	<i>Trumpeter</i>	56MDAM	56MDAM-10
Heavy	6.5 oz (184,28g)	<i>Knight</i>	56HVAM	56HVAM-10
Extra Heavy	8.5 oz (240,98g)	<i>Jester</i>	56XHAM	56XHAM-10

3/8" (9,52mm) Purple Bag

	Oz (g)	Figures	5000 pcs	1000 pcs
Light	2.5 oz (70,88g)	<i>Pirate</i>	38LTAM	38LTAM-10
Medium	4.5 oz (127,58g)	<i>Barbarian</i>	38MDAM	38MDAM-10
Heavy	6.5 oz (184,28g)	<i>Roman Soldier</i>	38HVAM	38HVAM-10

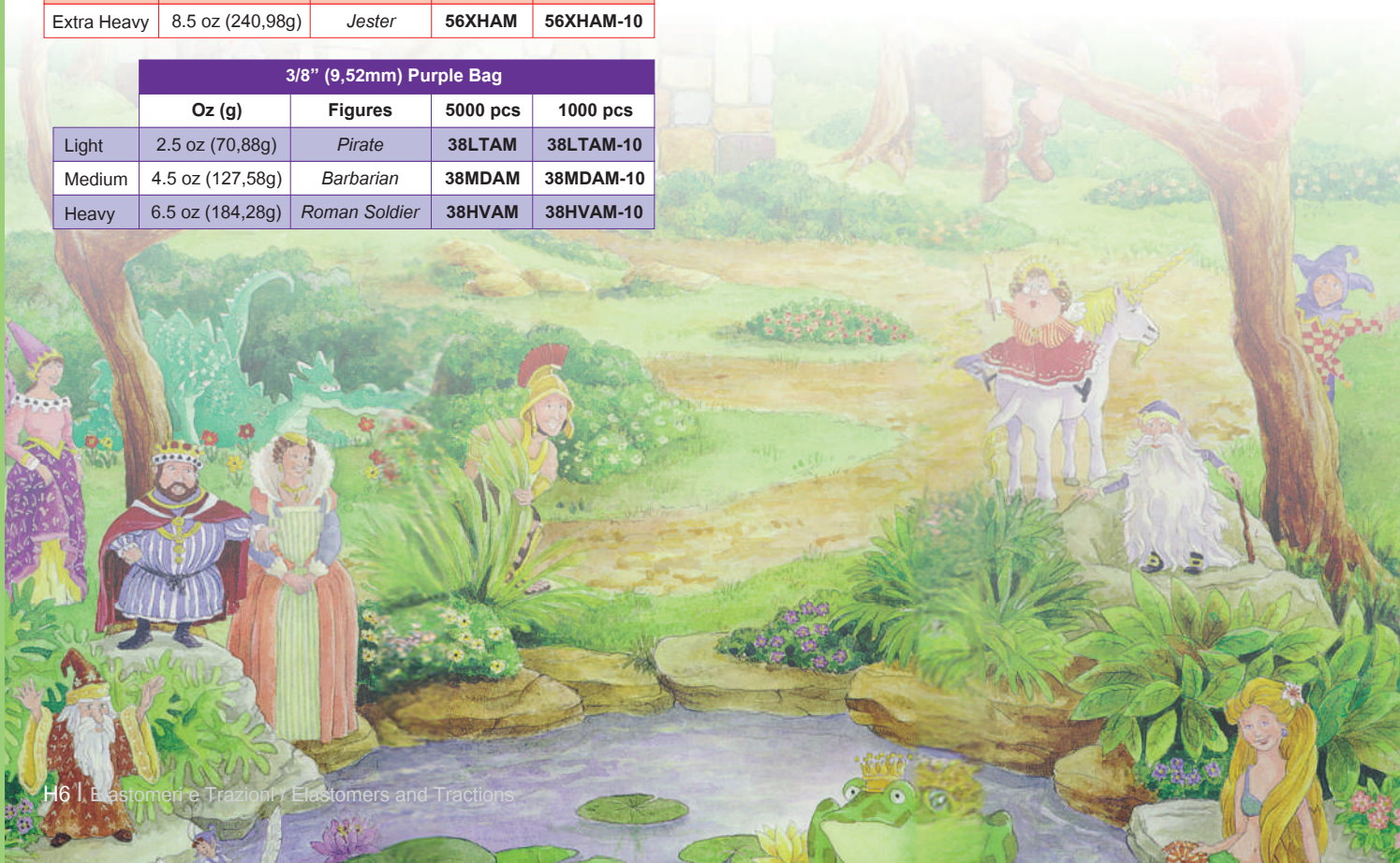

Elastici Intraorali / *Intraoral latex elastics*

Gli elastici intraorali della linea Maximus sono prodotti in puro lattice e seguono gli standard di qualità necessari a garantire l'erogazione delle forze richieste. Su ogni busta viene indicato il diametro e la forza per una rapida ed univoca identificazione dell'elastico. Ogni busta contiene 1000 pz.

The intraoral elastics of the Maximus line are produced in pure latex and follow the quality standards necessary to ensure the delivery of the required forces.

The diameter and strength are indicated on each bag for a quick and unambiguous identification of the elastic. Each bag contains 1000 pcs.



1/8" (3,18mm) Orange Bag				
	Oz (g)	Figures	5000 pcs	1000 pcs
Light	2.5 oz (70,88g)	Plutone	MX18LT	MX18LT-10
Medium	4.5 oz (127,58g)	Nettuno	MX18MD	MX18MD-10
Heavy	6.5 oz (184,28g)	Wizard	MX18HV	MX18HV-10

3/16" (4,77mm) Blue Bag				
	Oz (g)	Figures	5000 pcs	1000 pcs
Light	2.5 oz (70,88g)	Venere	MX36LT	MX36LT-10
Medium	4.5 oz (127,58g)	Apollo	MX36MD	MX36MD-10
Heavy	6.5 oz (184,28g)	Fortuna	MX36HV	MX36HV-10

1/4" (6,35mm) Green Bag				
	Oz (g)	Figures	5000 pcs	1000 pcs
Light	2.5 oz (70,88g)	Diana	MX14LT	MX14LT-10
Medium	4.5 oz (127,58g)	Ercole	MX14MD	MX14MD-10
Heavy	6.5 oz (184,28g)	Cerere	MX14HV	MX14HV-10

5/16" (7,95mm) Red Bag				
	Oz (g)	Figures	5000 pcs	1000 pcs
Light	2.5 oz (70,88g)	Vulcano	MX56LT	MX56LT-10
Medium	4.5 oz (127,58g)	Bacco	MX56MD	MX56MD-10
Heavy	6.5 oz (184,28g)	Minerva	MX56HV	MX56HV-10

3/8" (9,52mm) Purple Bag				
	Oz (g)	Figures	5000 pcs	1000 pcs
Light	2.5 oz (70,88g)	Giunone	MX38LT	MX38LT-10
Medium	4.5 oz (127,58g)	Giove	MX38MD	MX38MD-10
Heavy	6.5 oz (184,28g)	Mercurio	MX38HV	MX38HV-10



Strumento posizionamento elastici

Elastic placement tool	EPT100
100 pcs / pack	

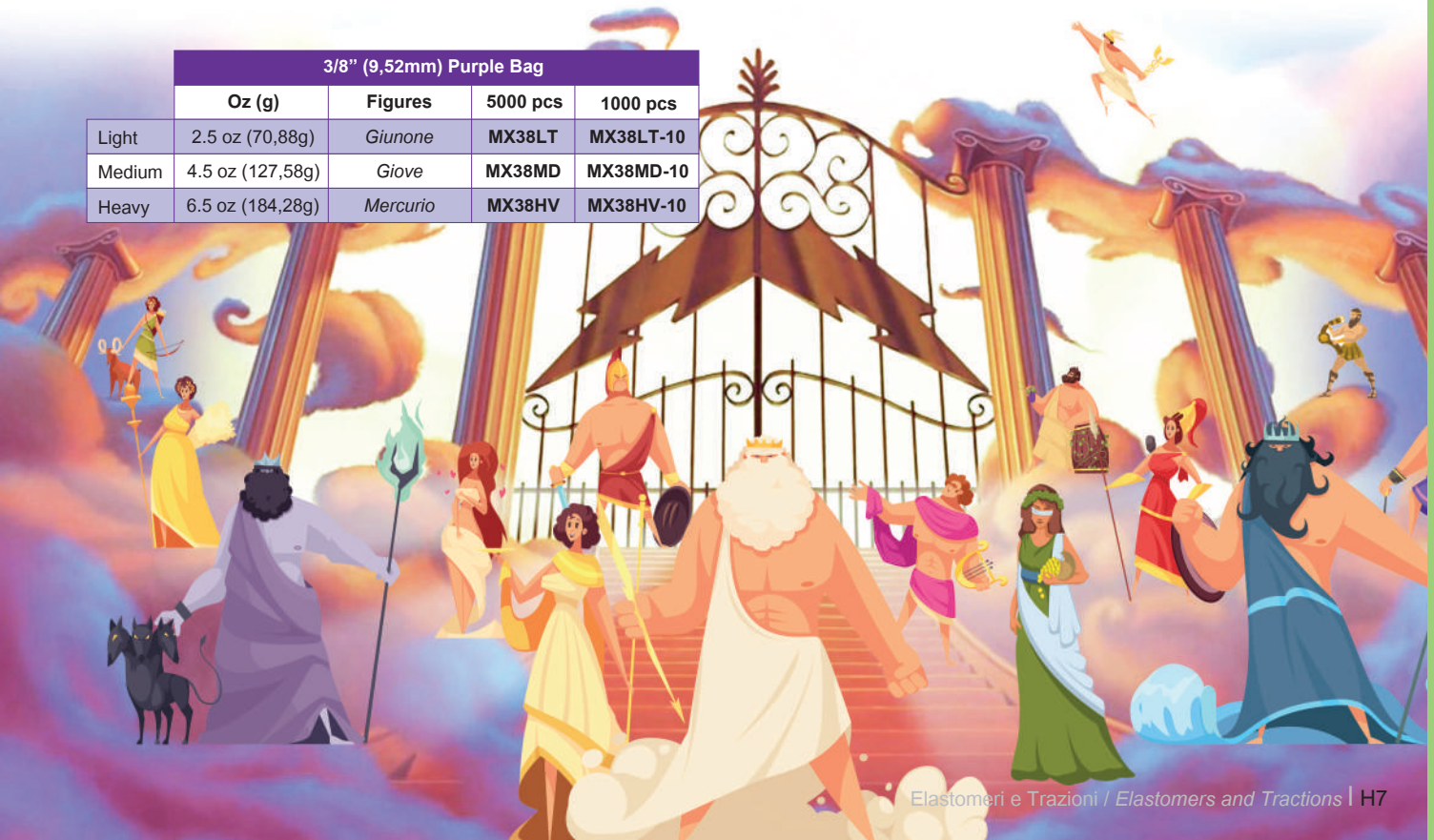

Elastici Extraorali / *Extraoral latex elastics*

Gli elastici extraorali, sono prodotti in puro lattice di grado medicale. Garantiscono un'alta elasticità ed assicurano forze precise e costanti. Confezionati in bustine di differenti colorazioni per un'immediata identificazione del diametro.

Manufactured from the finest medical grade latex to ensure reliable force delivery. For an immediate identification, each diameter has an identification colour on the bag.

Elastici Extraorali / *Extraoral elastics*

Oz (g)	1/4 (6,35mm)	5/16 (7,9mm)	3/8 (9,5mm)	1/2 (12,7mm)
8 oz.	AX014B	AX056B	AX038B	AX012B
16 oz.	AX114B	AX156B	AX138B	AXH12B
1000 pcs / pack				



Elastici Latex Free / *Non-latex elastics*

Elastici privi di lattice, ideali per pazienti allergici. Preconfezionati in bustine monopaziente da 100 pezzi; forniti in cartoni dispenser da 100 bustine o disponibili in confezioni da 10 bustine.

Non-latex elastics, ideal for patient allergic to latex. Bags with 100 pieces. Available carton dispenser with 100 bags, or 10 pouches per pack.

Non-latex elastics

	Oz (g)	3/16 (4,77mm)	1/4 (6,35mm)
Medium - 10 bag	4.5 oz (127,58g)	LFM36-10	LFM14-10
Heavy - 10 bag	6.5 oz (184,28g)	LFH36-10	LFH14-10
Medium - 100 bag	4.5 oz (127,58g)	LFM36	LFM14
Heavy - 100 bag	6.5 oz (184,28g)	LFH36	LFH14
1 bag = 100 pcs			



Dinamometri / *Safety release modules*

Trazioni di sicurezza usate con cuffie o con trazioni cervicali; le molle situate all'interno, permettono di esprimere forze costanti da 450 g a 750 g.

Safety release modules for headcaps or cervical neckpads use. Specially retention springs release 450 g to 750 g outward force.

Safety release modules

	450 g	600 g	750 g
Black	AA0K450	AA0K600	AA0K750
Fucsia	AA0F450	AA0F600	AA0F750
Light Blue	AA0B450	AA0B600	AA0B750
10 pcs / pack			



Safety release modules with metal hook

	450 g	600 g	750 g
Blue denim	SRDB450	SRDB600	SRDB750
Black	SRBK450	SRBK600	SRBK750
10 pcs / pack			



Fascia per trazioni cervicali / *Cervical neckpads*

Fasce per trazioni cervicali, impiegate per la trazione bassa.

Cervical neckpads used for low tractions.

Cervical neckpads

Royal Blue	CPRB10
Blue Denim	CPDB10
Pink	CPPK10
5 pcs / pack	



Cuffia per trazioni di sicurezza / *High pull headcaps*

Cuffie per trazioni di sicurezza, sulle quali vengono montati i dinamometri.

High pull headcaps on which dynamometers.

High pull headcaps

	Small	Large
Black	HPSBK5	HPLBK5
Red	HPSRD5	HPLRD5
Royal Blue	HPSRB5	HPLRB5
5 pcs / pack		



- Merce disponibile / Goods available
- Merce a richiesta / Goods on request

Cuffia con mentoniera / *Chin cup headcap*

Cuffia con mentoniera; confortevole con regolazione in velcro.
Comfortable headcap with chin cups attached with Velcro.

Chin cup headcap

Junior	SOFCJ
Regular	SOFCR
1 pc / pack	

Refill headcap

Headcap	SOFC
1 pc / pack	

Refill



Custodia in tessuto / *Storage case*

Pratica custodia colorata per archi, con chiusura a velcro per proteggere e custodire l'arco.
Colored storage case, with velcro closure to protect the facebows.

Storage case

Red	HGSTRD
Blue	HGSTRB
5 pcs / pack	



Lip Bumpers

Lip Bumpers con gancio in acciaio, rivestito in resina colorata, disponibile in cinque misure più una universale. Il diametro del filo è di Ø.045. La confezione è da 2 pezzi.

Lip Bumpers with steel hook and coloured lip pad, available in five sizes plus universal. Ø .045 diameter, 2 per pack.

Lip bumpers

	size 1 83 mm	size 2 90 mm	size 3 97 mm	size 4 104 mm	size 5 111 mm	Universal
White	CCLB103	CCLB203	CCLB303	CCLB403	CCLB503	CCLB003
Orange	CCLB104	CCLB204	CCLB304	CCLB404	CCLB504	CCLB004
Pink	CCLB110	CCLB210	CCLB310	CCLB410	CCLB510	CCLB010
2 pcs / pack*						

* Confezione economica Universali da 10 pz. (aggiungere alla fine del codice la lettera **E**) Ex. CCLB103**E**

* 10 pcs pack Universal (add **E** to the end of code) Ex. CCLB103**E**



■ Merce disponibile / Goods available

■ Merce a richiesta / Goods on request

Archi extraorali / *Facebows*

Archi extraorali in acciaio, saldati a laser per assicurare nessun distacco tra arco interno ed esterno. Disponibili in cinque differenti misure, più una universale. Il diametro dell'arco è Ø.045. La confezione è da 1 pezzo.

Stainless Steel facebows with laser welding to ensure no separation between the internal and the external arch. Available in five different sizes, plus one universal. Ø .045 diameter; 1 piece pack.

Facebows

	Short	Medium
Size 1 (83 mm)	115 K-1	115 M-1
Size 2 (90 mm)	115 K-2	115 M-2
Size 3 (97 mm)	115 K-3	115 M-3
Size 4 (104 mm)	115 K-4	115 M-4
Size 5 (111 mm)	115 K-5	115 M-5
Universal	115 K	115 M
1 pc / pack		



Arco con ansa / *Loops bow*

Maschera facciale / *Face mask*

Dispositivo di III^a classe; indicata per le retrusioni mascellari, prognatismi mandibolari e schisi palatali. Completamente costruita in acciaio, regolabile per tutte le necessità verticali e orizzontali.

III^a class appliance for maxillary retrusions, mandibular prognathisms and palatal cleft. Stainless Steel frame, bilateral and bilongitudinal adjustability for patient customization.

Small



Large



Universal



Facebows

Small	903012
Large	903011
Universal	903013
1 pc / pack	

■ Merce disponibile / *Goods available*

■ Merce a richiesta / *Goods on request*

Maschera facciale dinamica / *Dinamic face mask*

La Maschera regolabile Dinamica (Petit), è realizzata con appoggi, in plastica stampata, rivestiti con morbidi cuscinetti lavabili e intercambiabili. Gli appoggi per la fronte e per il mento sono completamente regolabili e permettono di adattare comodamente le parti anatomiche dei pazienti. L'angolo di trazione viene poi determinato regolando la barra di aggancio degli elastici, per fornire forze orizzontali, verso l'alto o verso il basso a seconda di quanto necessario. La regolazione della maschera facciale viene effettuata con una chiave esagonale inclusa nella confezione. Si consiglia l'applicazione di elastici 1/2 " con forze da 8 o da 16 onces.

Petit dynamic face mask is made with plastic rests, coated with washable and changeable soft pads. Fully adjustable forehead and chin rests allow for adaptation to most patient's anatomic structure. The angle of traction is then determined by adjusting the elastics engagement bar to deliver horizontal, upward or downward force as necessary. Face mask adjustments are made with a wrench (included). 1/2" elastics with 8 or 16 oz. are recommended.

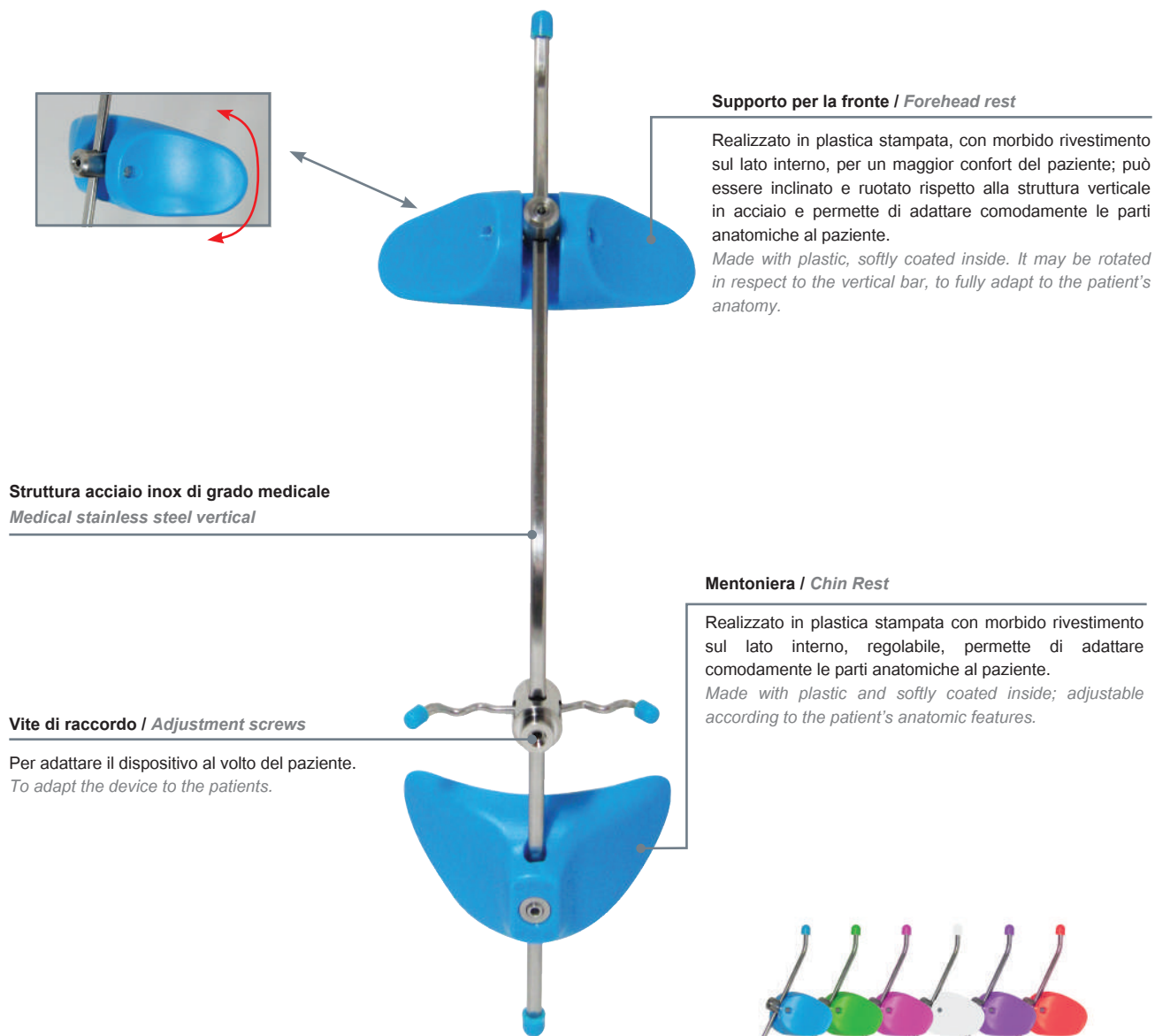

Supporto per la fronte / *Forehead rest*

Realizzato in plastica stampata, con morbido rivestimento sul lato interno, per un maggior confort del paziente; può essere inclinato e ruotato rispetto alla struttura verticale in acciaio e permette di adattare comodamente le parti anatomiche al paziente.

Made with plastic, softly coated inside. It may be rotated in respect to the vertical bar, to fully adapt to the patient's anatomy.

Struttura acciaio inox di grado medicale

Medical stainless steel vertical

Vite di raccordo / *Adjustment screws*

Per adattare il dispositivo al volto del paziente.
To adapt the device to the patients.

Mentoniera / *Chin Rest*

Realizzato in plastica stampata con morbido rivestimento sul lato interno, regolabile, permette di adattare comodamente le parti anatomiche al paziente.

Made with plastic and softly coated inside; adjustable according to the patient's anatomic features.

Dinamic face mask

Blue	AA05000B
Fuchsia	AA05000F
Green	AA05000G
Purple	AA05000P
White	AA05000W
Red	AA05000R
1 pc / pack	

■ Merce disponibile / *Goods available*

■ Merce a richiesta / *Goods on request*

Accessori / Accessories

Ortho Control

Gli Ortho Control sono dei dispositivi preformati per l'ortodonzia intercettiva. Essi vengono indicati per pazienti in età evolutiva dagli 8 ai 12 anni, per guidare l'eruzione ed il posizionamento dei canini e dei premolari, restituendo un rapporto oclusale idoneo, e nel contempo allineando i denti frontali garantendo un overbite/overjet ideale.

Gli Ortho Control possono essere usati anche in età adulta, ma si otterrà solo un movimento dentario e non scheletrico.

Inoltre possono essere impiegati come regolatori miofunzionali riequilibrando le forze muscolari.

Ortho Control are preformed appliances for intercepting orthodontics. They are recommended for patients from 8 to 12 years old, to guide erupting canines and bicuspids and to align front teeth to solve overjet or overbite problems. Ortho Control can be also employed in adults, providing that malformation is dental and not skeletal.

Moreover, they can be used as miofunctional regulators rebalancing muscular forces.

Indicazioni / Recommended for:

- Affollamento / Crowding
- Overjet
- Over-bite
- Malocclusioni di I e II classe / I and II class malocclusion
- Curva di spee accentuata / Accentuated spee's curve
- Ipertonicità delle labbra / Hypertonic lips
- Open bite
- Rotazioni / Rotation
- Cross bite Premolari / Bicuspid cross bite
- Coordina le Arcate / Arcate coordination

Vantaggi / Benefits:

- Preformati per un veloce piazzamento
Preformed for a quick placement
- Maggiore efficacia nel trattamento / Highest treatment efficacy
- Risparmio di tempo / Time saving
- Costi ridotti / Cost reduction
- Procedure più spedite / Quick procedures
- Sterilizzabile / Sterilizable
- Comfort nell'utilizzo / Comfortable use

Kit

- Ortho Control assortiti - 6 pz. / Assorted Ortho Control - 6 pcs (AA050 - AA055 - BB040 - BB050 - BB055 - BB060)
- Misurini - 6 pz. / Measuring - 6 pcs
- Istruzioni / Instruction
- Depliant ortho control

Ricambio / Refill

- Ortho Control - 1 pz. / Ortho Control - 1 pc
- Misurino - 1 pz. / Measuring - 1 pcs

Kit

Ortho Control Kit	AB010
6 pcs / pack	

Ricambio / Refill

Ortho Control - shape B040	BB040
Ortho Control - shape B050	BB050
Ortho Control - shape B055	BB055
Ortho Control - shape B060	BB060
1 pc / pack	

Kit



Refill

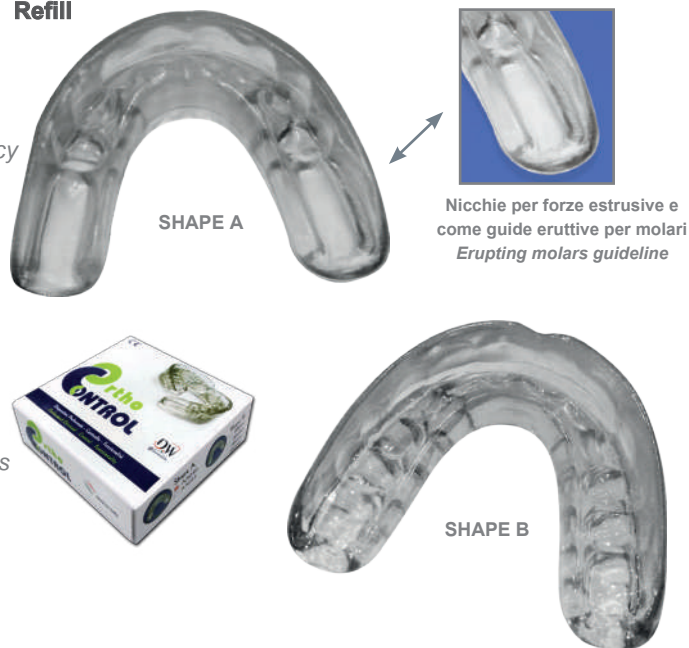

Ruler



Ortho Control - shape A050	AA050
Ortho Control - shape A055	AA055
1 pc / pack	

Ruler	AB011
10 pcs / pack	

■ Merce disponibile / Goods available

■ Merce a richiesta / Goods on request

Bite Bumper™

Bite Bumper™ viene adoperato per casi di morso aperto o profondo, consentendo di scavalcare il morso inverso. Sono prodotti con un polimero di composito che assicura una biocompatibilità per tutti i soggetti sensibili al Nickel. Per il fissaggio dei Bite possono essere usati i metodi tradizionali, in quanto la bassetta è a ritenzione meccanica.

Bite Bumper™ works to open deep bite cases by allowing the anteriors to ride up and out of occlusion. Bite-Bumper is made of a composite polymer that ensures biocompatibility in nickel sensitive patients. It can be bonded in traditional manner thanks to its mechanical bonding base.

Indicazioni / How to use:

1. Posizionare la dima contro il bordo incisale / Put the placement-jig against the incisal edge
2. Rimuovere la dima / Remove the jig
3. Bite-Bumper™ è pronto / Bite-Bumper™ ready

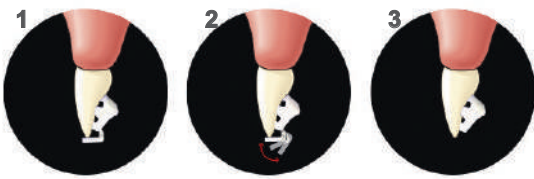

Bite Bumper™	BB-00-01
10 pcs / pack	

Bite Bumper™ è un marchio registrato da Gastenco International AB, Svezia / Bite Bumper™ is a registered trademark of Gastenco International AB, Sweden

Mini - Mold

Gli stampi vengono riempiti con composito fotopolimerizzante per la costruzione in studio di bottoni, bite, brackets temporanei, tubi per molari, ecc. Una valida soluzione per risolvere esigenze ed urgenze particolari.

The various molds can be used to construct buttons, bites, temporary brackets, molar tubes, etc. using a light curing composite. A valid solution for main urgency.

Kit

- 1 tip per ogni modello / 1 of each mold
- 1 manico / 1 application handle

Mini Mold Kit	MMOHSK
6 pcs / pack	

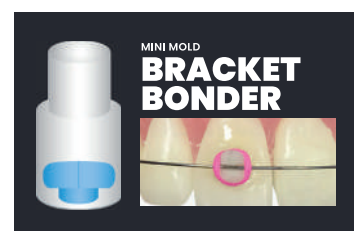
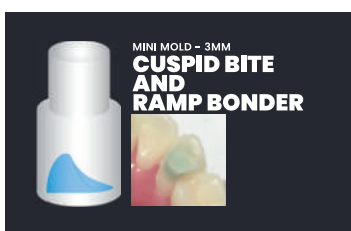
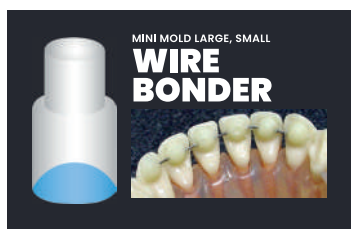

- Merce disponibile / Goods available
- Merce a richiesta / Goods on request

Archetto e Strisce per stripping / Stripping instrument and lightning strips

Strumento interamente in acciaio, sterilizzabile in autoclave, comodo e preciso nelle manovre di utilizzo.
Interproximal stripping instrument, full stainless steel, sterilizable, comfortable and precise.

Archetto per stripping / Stripping instruments

Stripping instruments	EI-820
1 pc / pack	



Strisce per stripping / Lightning strips

	Un lato / Single sided	Due lati / Dual sided
	.021 mm	.030 mm
4 mm	LSSSM4M	LSDSM4M
6 mm	LSSSM6M	LSDSM6M
8 mm	LSSSM8M	LSDSM8M
12 pcs / pack		

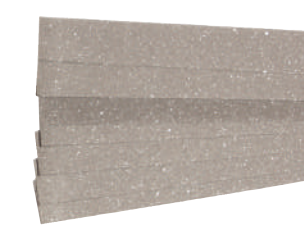

Disco diamantato per stripping / Interproximal diamond discs

Disegnato per ridurre lo smalto nelle zone interprossimali. Confezionato in un singolo pezzo, completo di mandrino.
Designed for effective enamel reduction, interproximal stripping; sold individually mounted on mandrel.

Disco diamantato / Diamond discs

Un lato / Single sided	Due lati / Dual sided
DISCSSUM	DISCDSM
1 pc / pack	



Strisce per splintaggio / Splinting strips

Strisce da .027" x .011": intrecciato a 8 strati, piatto, morbido, senza memoria, facile da adattare alla faccia palatale del dente, indicato per il lingual retainer. Confezione da 10 pezzi.

8 strands wire, .027" x .011", plain, soft, without memory; easy to adapt, indicated for lingual retainer. 10 pieces pack.

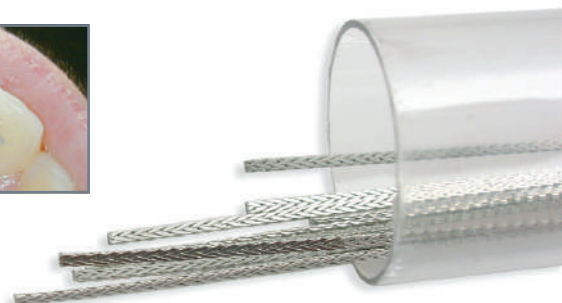

Orthodontic splinting strips

Lingual retainer	BAB2
10 pcs / pack	

Frese per composito / Removal and finishing burs

Frese adatte per la rimozione di residui di compositi, dopo il debonding o per la rifinitura di eccessi. Confezionati singolarmente.
Burs for removing residuals and for finishing. Sold individually.

Frese in tungsteno Tungsten Burs



RSB 118S
1 pc / pack



RSB2 218
1 pc / pack



RSBL 118L
1 pc / pack

Frese in fibra di vetro autorigeneranti Self-healing glass fiber burs

MADE IN ITALY



00400168
6 pcs / pack



00400169
6 pcs / pack

Fresa a punta per materiali termoplastici / Pointed bur for thermoplastic materials

Nello stampaggio termoplastico si usano frese a punta per tagli e forature precise. La punta conica regola la larghezza del taglio e il profilo speciale evita l'incollamento dei materiali morbidi.

Pointed burs are used in thermoplastic molding for precise cutting and punching. The tapered tip adjusts the width of the cut, and the special profile prevents sticking of soft materials.

- Lunghezza: 9 mm;
Length: 9 mm;
- Ø 1/16 mm: 023;
- Velocità ottimale: 25.000 giri/m, materiali morbidi; 5.000 - 10.000 giri/m materiali duri.
Optimal speed: 25.000 rpm, soft materials; 5.000 - 10.000 rpm hard materials.



C515.023HP
1 pc / pack

Spazzole a disco per materiali termoplastici / Disc brushes for thermoplastic materials

Le spazzole a pori aperti sono ideali per lavorare materiali termoplastici senza causare surriscaldamento e deformazioni.

Open-pore brushes are ideal for processing thermoplastic materials without causing overheating and deformation.

Disco a grana grossa Coarse-grained disc



2140
5 pc / pack

Disco a grana media Medium-grained disc



2141
5 pc / pack

Disco a grana fine Fine-grained disc



2142
5 pc / pack



Dabliu Apribocca / Cheek retractor

Apribocca in policarbonato con o senza contenzione linguale, per una maggiore visione della cavità orale.
 Cheek retractor in polycarbonate with or without lingual dental splinting, for a better complete vision of the oral cavity.

Apribocca con fermalingua

Medio - Largo / Trasparente - Blu
 Cheek retractor with tongue guard
 Medium - Large / Clear-blue



Autoclavabile 121°C

Cheek retractor with tongue guard - Clear - Medium - 2 pcs	00340261
Cheek retractor with tongue guard - Clear - Large - 2 pcs	00340262

Divaricatore labiale

Adulto - Bambino
 Lip retractor
 Adult - Child



Autoclavabile 121°C

Lip retractor - Adult - 2 pcs	00340266
Lip retractor - Child - 2 pcs	00340267

Apribocca con alette

Cheek retractor w/extension



Autoclavabile 134°C

Cheek retractor w/extension - 1 pc	CR-00-01
------------------------------------	-----------------

Apribocca per foto

Adulto - Bambino
 Lip retractor - Photo
 Adult - Child



Autoclavabile 134°C

Lip retractor - Photo - Adult - 1 pc	LR-00-01
Lip retractor - Photo - Child - 1 pc	LR-00-02

Apribocca in acciaio bilaterale

Bilateral stainless steel lip retractor



Autoclavabile 134°C

Cheek retractor with tongue guard - Clear - Medium - 1 pc	PL-820
---	---------------

■ Merce disponibile / Goods available

■ Merce a richiesta / Goods on request

Apribocca verticale

Adulto - Bambino

Vertical cheek retractor

Adult - Child



Autoclavabile 121°C

Vertical cheek retractor - Adult - 10 pcs	00340257
Vertical cheek retractor - Child - 10 pcs	00340265

Apribocca con arco in metallo

Adulto - Bambino

Cheek retractor with metal arch

Adult - Child



Autoclavabile 134°C

Cheek retractor with metal arch - Adult - 1 pc	CH1
Cheek retractor with metal arch - Child - 1 pc	CH2

Divaricatore labiale monolaterale

Unilateral lip retractor



Autoclavabile 121°C

Unilateral lip retractor - 2 pcs	00340268
----------------------------------	-----------------

Apribocca in gomma con asta di collegamento a C

Rubber mouth opener with C-shaped connecting rod



Autoclavabile 121°C

Rubber lip retractor - Adult	00340277
------------------------------	-----------------

Apribocca in acciaio bilaterale

Bilateral stainless steel lip retractor

Kit:

- Set x 3 pcs

Ricambio / Refill

- Piccolo / Small - 1 pc
- Medio / Medium - 1 pc
- Grande / Large - 1 pc



Kit

Dabliu Bite Opener - Kit - 3 pcs	00340260
----------------------------------	-----------------

Ricambio / Refill

Dabliu Bite Opener - Small - 1 pc	00340260S
Dabliu Bite Opener - Medium - 1 pc	00340260M
Dabliu Bite Opener - Large - 1 pc	00340260L

- Merce disponibile / Goods available
- Merce a richiesta / Goods on request

Specchi per foto diagnostiche / Photographic Mirrors

Specchi per foto, insuperabili nella qualità, offrono agli utilizzatori delle immagini perfette senza distorsioni. La superficie è coperta da due strati di cromo per restituire la massima qualità di riflesso. Gli specchi riflettono ambo i lati.

Unsurpassed in quality, our photographic mirrors offer the finest possible image transfer. Double-side coated with chromium for maximum reflective qualities. Mirrors reflect both sides.

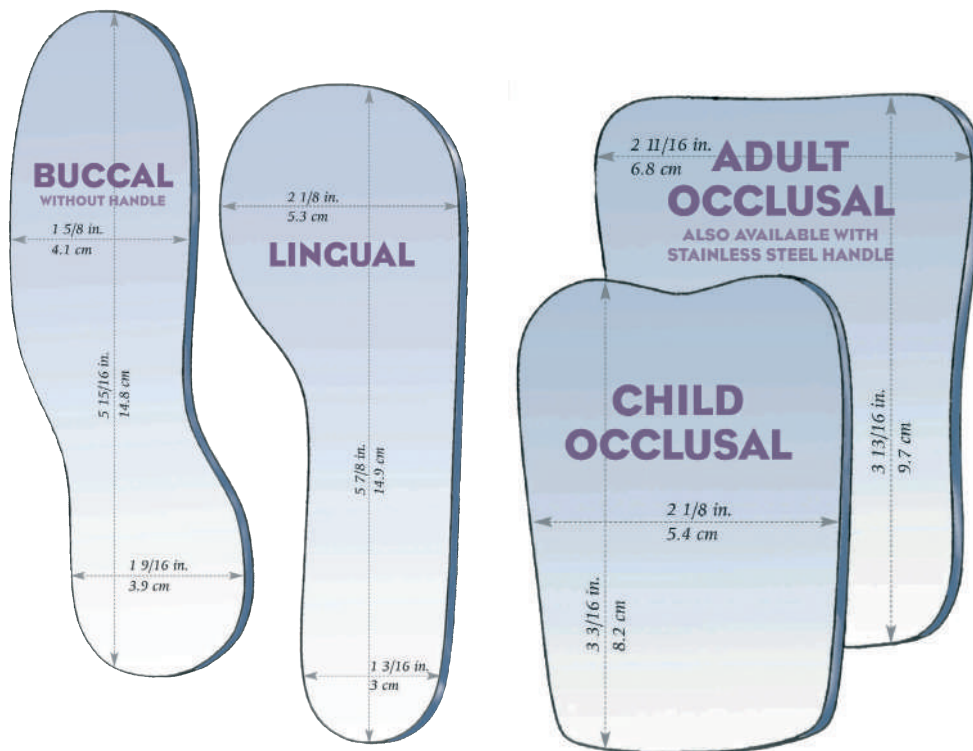

Photographic mirrors

Adult Occlusal	MXPM-004
Child Occlusal	MXPM-003
Lingual	MXPM-002
Buccal	MXPM-001
1 pc / pack	

Dabliu Wax cera ortodontica *Orthodontic wax*

Cera ortodontica, garantisce maggiore protezione dal contatto diretto degli attacchi e archi.

Our Wax provides higher protection from contact during orthodontic treatment.



Dabliu Wax

Orthodontic wax	24654100
36 pcs / pack	

Fogli in acetato per tracciati *Acetate tracing sheets*

Fogli in acetato per tracciati cefalometrici.

Formati: 203 x 254 mm. Confezione 100 fogli.

Cephalometric acetate tracing paper.

Size 203 x 254 mm, 100 sheets.



Fogli in acetato per tracciati

Acetate tracing paper	ATP100810
100 pcs / pack	

Dispenser per attacchi / *Brackets dispenser*



3P1102

1 pc / pack



3P1100

10 pcs / pack

Zoccolatori per modelli *Plastic model bases*



Plastic model bases

Plastic model - 10 pcs	3P1010
Plastic model - 100 pcs	3P1000

Porta Pinze *Plier Holder*

19 fori / 19 holes



Porta pinze

Plier dispenser	EI-000
1 pc / pack	

Porta Pinze *Plier Holder*

20 fori / 20 holes



Porta pinze

Plier rack	PLRK020
1 pc / pack	

■ Merce disponibile / Goods available
■ Merce a richiesta / Goods on request

Kit ortodontico prevenzione / Orthodontic prophylaxis kit

Kit ortodontico composto da: spazzolino ortodontico, specchietto, filo interdentale, cera ortodontica, spazzolino da viaggio, clessidra e scovolino.

The kit contains orthodontic: tooth brush, hand mirror, dental floss, orthodontic wax, travel tooth brush, hourglass and interdental brushes.



Orthodontic prophylaxis kit	38008
Kit	

Cucchiaini porta impronte per ortodonzia / Disposable impression trays

Cucchiaini porta impronte anatomici in plastica rigida, dotati di manico lungo (che permette un'ottima presa da parte del medico) e strisce perforate (che offrono all'alginato una maggiore aderenza senza l'utilizzo di adesivi). Disponibili in differenti formati dal n° 1 (piccolo) al n° 6 (grande). La misura è visibile sul manico del cucchiaino.

Disposable impression trays are rigid, color-coded anatomical plastic trays with perforation strips that offer economical use and disposability. Long handles provide sure grip while retention slots secure alginate without need for adhesives. They are available in size 1 (smallest) up to size 6 (largest); size is imprinted on handle.

Disposable impression tray

Upper	
N° 1	DITU01 10 pcs
N° 2	DITU02 10 pcs
N° 3	DITU03 10 pcs
N° 4	DITU04 10 pcs
N° 5	DITU05 10 pcs
N° 6	DITU06 10 pcs

Lower	
N° 1	DITL01 10 pcs
N° 2	DITL02 10 pcs
N° 3	DITL03 10 pcs
N° 4	DITL04 10 pcs
N° 5	DITL05 10 pcs
N° 6	DITL06 10 pcs

Assorted kit	DITAS 60 pcs
--------------	--------------



■ Merce disponibile / Goods available

■ Merce a richiesta / Goods on request

Ortho Box & Ortho Bite

Ortho Box e Ortho Bite sono contenitori indicati per la custodia ed il trasporto di placche ortodontiche, bite e apparecchi funzionali.
Ortho Box and Ortho Bite are containers recommended for the safe keeping and the transport of orthodontic appliances, bites and functional devices.

Caratteristiche / Characteristics:

- Sono realizzati in plastica atossica di tipo alimentare, priva di lattice e ftalati
They are made of non-toxic and food-grade plastic, latex and phthalates free
- Ortho box: h 40 mm satinato
Ortho box: h 40 mm frosted
- Ortho box: h 30 mm lucido
Ortho box: h 30 mm polished

Vantaggi / Advantages:

- Pratici e resistenti
Practical and resistant
- Disinfettabili con soluzione a freddo
Disinfectable with cold solution

Packaging:

1 pcs

Ortho Bite



Ortho Box



Ortho Box

Ortho Box - Orange	00340199
Ortho Box - White	00340201
Ortho Box - Green	00340202
Ortho Box - Yellow Neon	00340203
Ortho Box - Fuxia Neon	00340204
Ortho Box - Red	00340205
Ortho Box - Blue	00340206
Ortho Box - Light Blue	00340207
Ortho Box - Silver	00340208
Ortho Box - Lemon Yellow	00340215
Ortho Box - Violet	00340210
Ortho Box - Fuxia	00340211
Ortho Box - Orange Neon	00340212
Ortho Box - Green Neon	00340213
Ortho Box - Black	00340217

Ortho Bite

Ortho Bite - Orange	00340227-N
Ortho Bite - Fuxia Neon	00340228-N
Ortho Bite - Light Blue	00340229-N
Ortho Bite - White	00340230-N
Ortho Bite - Green	00340231-N
Ortho Bite - Fuxia	00340232-N
Ortho Bite - Yellow Neon	00340233-N
Ortho Bite - Violet	00340234-N
Ortho Bite - Blue	00340235-N
Ortho Bite - Red	00340236-N
Ortho Bite - Yellow	00340237-N
Ortho Bite - Black	00340239-N
Ortho Bite - Grey	00340240-N
Ortho Bite - Green Neon	00340241-N
Ortho Bite - Green Apple	00340242-N
Ortho Bite - Orange Neon	00340243-N

■ Merce disponibile / Goods available
 ■ Merce a richiesta / Goods on request

Portaprotesi / Prosthesis cases

Contenitore Portaprotesi per la disinfezione a freddo di protesi, apparecchi funzionali e ortodontici.

Prosthesis cases for the cold disinfection of prosthesis; functional and orthodontic devices.

Caratteristiche / Characteristics:

- Sono realizzati in plastica atossica di tipo alimentare, priva di lattice e ftalati
They are made of non-toxic and food-grade plastic, latex and phthalates free
- Dotati di filtro per impurità
Provided with an impurity filter

Vantaggi / Advantages:

- Pratici e resistenti
Practical and resistant
- Disinfettabili con soluzione a freddo
Disinfectable with cold solution

Packaging:

1 pcs



Blue



Fuxia



Fuxia Neon



Green



Light Blue



Orange



Red



Violet



Lemon Yellow



White



Apple Green

Prosthesis case

Prosthesis Case - Violet	00771460
Prosthesis Case - Green	00771464
Prosthesis Case - White	00771466
Prosthesis Case - Light Blue	00771467
Prosthesis Case - Orange	00771468
Prosthesis Case - Fuxia	00771471
Prosthesis Case - Lemon Yellow	00771472
Prosthesis Case - Fuxia Neon	00771472FN
Prosthesis Case - Blue	00771473
Prosthesis Case - Red	00771474
Prosthesis Case - Apple Green	00771475

■ Merce disponibile / Goods available

■ Merce a richiesta / Goods on request

S&TCR

Il Second e il Third Class Resolver (S&TCR)

S&TCR sono degli apparecchi ortopedici fissi funzionalizzanti a stimolo propriocettivo; utilizzano gli stessi principi di altri apparecchi ortopedici, ma funzionando 24 ore/die, permettono di ottenere, in tempi medi più rapidi, il risultato terapeutico a prescindere dalla collaborazione del paziente.

I dispositivi agiscono da sistemi funzionalizzanti in quanto lavorano durante le funzioni proprie dell'apparato stomatognatico (masticazione, deglutizione, fonazione).

S&TCR are two fixed orthopaedic devices functioning with proprioceptive stimulus, using the same principles as other orthopaedic devices, but thanks to their 24 hours-a-day action, they get the therapeutical result independently from the patient cooperation, in shorter time. The devices act as functional systems because of their work, simultaneous to the stomatognathic apparatus functions (mastication, deglutition, phonation).



II^a Classe su filo ortodontico
II^a Class on orthodontic wire



II^a Classe su bande
II^a Class on bands



III^a Classe su bande
III^a Class on bands

S&TCR
Second&Third
MADE IN ITALY
Class Resolver

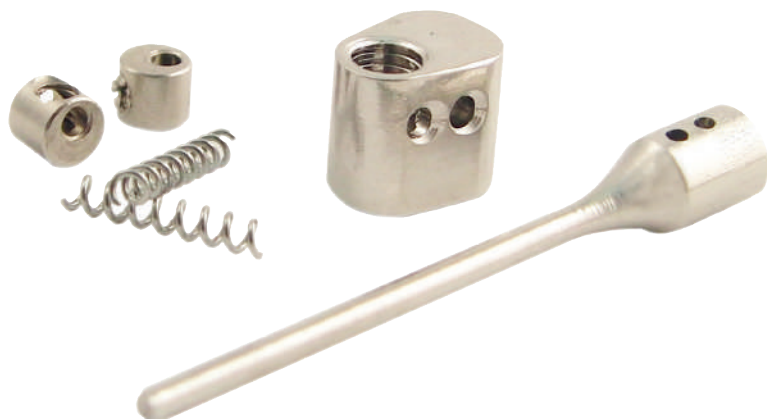

S&TCR

SCR (II ^a class)	000010
SCR (III ^a class)	000011
1 case / pack	

■ Merce disponibile / Goods available

■ Merce a richiesta / Goods on request

S&TCR per la risoluzione delle latero-deviazioni

L'S&TCR, in particolare nella versione SCR può essere utilizzato con molta facilità di impiego e con successo per la risoluzione delle seconde Classi latero-deviate, potendo agire con attivazione asimmetrica.

Agendo 24 ore/die sarà possibile correggere la latero-deviazione, in quanto lo stimolo continuo proveniente dai recettori muscolari avrà il massimo delle possibilità di cambiare l'engramma neuro-muscolare, grazie alla caratteristica della plasticità del tessuto neuronale.



Prima



Dopo

Utilizzo dell'SCR su filo .021 x .025 per correzione latero deviazione

L'S&TCR, in particolare nella versione SCR può essere utilizzato con molta facilità di impiego e con successo per la risoluzione delle seconde Classi latero-deviate, potendo agire con attivazione asimmetrica, sfruttando apparecchiature multibrackets, montando il dispositivo su fili in acciaio .021" x .025" o in alternativa su fili .019" x .025".

Agendo 24 ore/die sarà possibile correggere la latero-deviazione in quanto lo stimolo continuo proveniente dai recettori muscolari avrà il massimo delle possibilità di cambiare l'engramma neuro-muscolare, grazie alla caratteristica della plasticità del tessuto neuronale.



■ Merce disponibile / Goods available

■ Merce a richiesta / Goods on request

Second Class Revolver (SCR) per la risoluzione delle II^a classi

Il Second Class Resolver (SCR) per le seconde classi, non obbliga la mandibola nella stessa posizione (come succede con l'Herbst), in quanto, le arcate rimangono indipendenti l'una dall'altra e soprattutto, lo stimolo che viene indotto a carico della mandibola, è di tipo propriocettivo. Grazie al contatto propriocettivo tra i 2 piani di scivolo (superiore Skibar e inferiore Blockrun) presenti sull'apparecchiatura, e considerando che il condilo ed i muscoli masseteri vengono distratti di circa due millimetri, l'SCR consente di orientare sia i vettori muscolari che quelli della crescita condilare. Il risultato terapeutico si concretizza in un aumento della lunghezza del ramo mandibolare ed una crescita della mandibola in ante rotazione mandibolare.

- L'apparecchio risulta molto confortevole per il paziente, infatti dopo un periodo di adattamento di 4-7 giorni, il paziente convive tranquillamente.
- Quest'ultimo nelle sue 3 varianti (su multibrackets; sezionale 4-6 sui 4 quadranti; ferula vestibolare da 6 a 6 superiore e inferiore) è collocato nel vestibolo del paziente lasciando il cavo orale libero.
- Ciò risulta vantaggioso sia nei confronti della masticazione, deglutizione e fonazione sia nei casi in cui dovesse essere necessario abbinare una terapia riabilitativa logopedica o fisioterapica. Tale possibilità configura una delle novità assolute del dispositivo, ovvero il fatto di poter utilizzare contestualmente un apparecchio ortopedico vero per la correzione del rapporto di classe scheletrica e la terapia miofunzionale e/o logopedia. Il tutto compatibile, con il contemporaneo impiego di apparecchiature specificamente ortodontiche (attacchi, bande, etc.). La riattivazione dell'SCR è semplice, dovendo agire esclusivamente su una vite di serraggio per mobilizzare il Blockrun. Lo scorrimento verso distale del Blockrun consentirà l'attivazione dell'apparecchio. Infatti, il nuovo modo di interfacciarsi del piano di scivolo inferiore con quello superiore, determina l'avanzamento mandibolare.



Prima

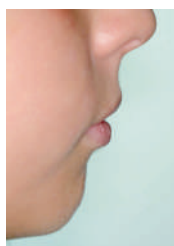

Dopo



Third Class Resolver (TCR) per la risoluzione delle III^a classi

Il Third Class Resolver (TCR) per le terze classi scheletriche, è un apparecchio ortopedico fisso, funzionalizzante, che non obbliga la mandibola nella stessa posizione e viene usato in età evolutiva. Esso utilizza gli stessi principi di tutti gli altri apparecchi ortopedici, ovvero la stimolazione delle suture circum-mascellari al fine di promuovere l'avanzamento del mascellare superiore.

La peculiarità di questo dispositivo è triplice:

1. Funzionando 24 ore/die, permette di ottenere il risultato terapeutico a prescindere dalla collaborazione del paziente ed in tempi medi più rapidi.
2. Gli stimoli per promuovere l'avanzamento del mascellare, grazie al disegno che caratterizza il TCR, partono dagli atti deglutitori; per quest'ultimo motivo, probabilmente, saranno caratterizzati da forze leggere.
3. La biomeccanica dell'apparecchio fa sì che la dinamica che porta a trasmettere la forza al mascellare per stimolarlo ad avanzare, ovvero la forza di azione e quella di reazione viene confinata in massima parte all'interno del dispositivo. Ciò si traduce in un trasferimento veramente minimo della forza di reazione, a carattere retrusivo, a carico della mandibola. Grazie al contatto propriocettivo tra i 2 piani di scivolo presenti sull'apparecchiatura, il TCR consente di riorientare sia i vettori muscolari che quelli della crescita condilare. In funzione del fatto che la struttura portante dell'S&TCR non invade il cavo orale, il TCR, si propone come uno degli strumenti terapeutici più validi per la risoluzione delle III Classi scheletriche in pazienti in fase di crescita, quando fosse necessaria anche la terapia miofunzionale. Tale possibilità, configura la novità assoluta del dispositivo, ovvero il fatto di poter utilizzare contestualmente un apparecchio ortopedico vero per la correzione del rapporto di classe scheletrica e la terapia miofunzionale e/o logopedia. Il tutto, compatibile, con il contemporaneo impiego di apparecchiature specificamente ortodontiche (attacchi, bande, etc). Stimolante, dunque, per l'ortodontista la scelta di diverse combinazioni terapeutiche, in funzione delle reali esigenze del paziente, consentendo, tra l'altro, un notevole abbattimento dei tempi terapeutici. L'apparecchio risulta confortevole per il paziente, infatti dopo un periodo di adattamento di 4-7 giorni, il paziente convive tranquillamente con il TCR. Quest'ultimo nelle sue 2 varianti (sezionale 4-6 sui 4 quadranti; ferula vestibolare da 6 a 6 superiore e inferiore) è collocato nel vestibolo del paziente lasciando il cavo orale libero. La riattivazione del TCR è semplice, dovendo agire esclusivamente su uno stop posto dietro la coilspring collocata dietro al blockrun nella struttura inferiore dell'apparecchio. Lo scorrimento verso mesiale dello stop produrrà l'avanzamento di tutto il sistema consentendo l'attivazione dell'apparecchio.



Prima

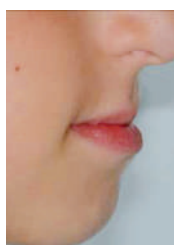

Dopo



S&TCR for the latero-deviation solution

S&TCR, in particular the SCR version, can be easily used with a successful result in the latero-deviation Second Class resolution, acting through an asymmetrical activation. Working 24 hours-a-day, this device corrects the latero-deviation problem thanks to the continuous stimulus coming from the muscular receptors that have the maximum possibility to change the neuromuscular engram, helped by the neuronal tissue plasticity.



Before



After

Use of SCR on .021 x .025 to correct a lateral deviation

SCR version is highly indicated for the resolution of second class latero-deviation, through an asymmetrical activation and working with multibrackets devices when setted on .021 x .025 or .019 x .025 wires. Working 24 hours-a-day, this device corrects the latero-deviation taking advantage of the continuous stimulus from the muscular receptors which has, thanks to the neuronal tissue plasticity, the maximum possibility to modify the engram.



Second Class Revolver (SCR)

The Second Class Resolver (SCR) does not force the mandible to keep the same position (as the Herbst does), because the arches stay independent of each other and very important factor: the stimulus inducted to the mandible is proprioceptive. Thanks to the proprioceptive contact between the two sliding planes of the device (upper Skibar and lower Blockrun) and to the fact that the condyle and the masseters are displaced of about 2 mm, the SCR succeeds in orientating either the muscular or the condylar growth vectors. The therapeutical result concretizes the mandibular branch advancement and the growth of the mandibular ante-rotation.

- The device results very comfortable for the patient; after 4-7 days the patient adapts to it easily.
- The device in its 3 different variants (on multibrackets, sectional 4-6 on the 4 quadrants, buccal splint from 6 to 6, upper and lower) is placed in the patient vestibule, leaving the oral cavity free.
- The oral cavity free is advantageous for mastication, deglutition and phonation, even when the logopaedic rehabilitative therapy or the physiotherapy are requested. This situation represents the innovation of this device: the possibility of using an orthopaedic device for the correction of the skeletal class and at the same time the performance of myofunctional and/or logopaedic therapies. All perfectly compatible with the use of orthodontic appliances (brackets, bands, etc.). The activation of SCR is easy: it is enough to act only on the tightening screw to mobilize the Blockrun. The Blockrun distal sliding activates the device. The brand new way of interfacing of both planes determines the mandibular advancement.



Before

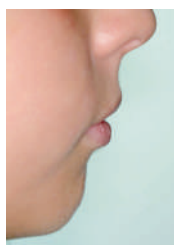

After

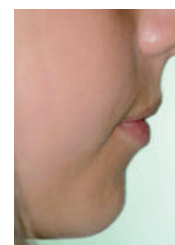

Third Class Resolver (TCR)

The Third Class Resolver is a fixed orthopaedic device which does not force the mandible to keep the same position, to be used in growth age. It uses the same orthopaedic devices principles as the stimulation of the circum-maxillary sutures with the aim of promoting the upper mandibular advancement. The characteristics of this device are:

1. Working 24 hours-a-day it enables the therapeutic result independently from the patient cooperation, in shorter time.
2. Thanks to the TCR design, the stimuli, promoting the mandibular advancement, are activated by the act of deglutition; for this reason, probably, they are characterized by light forces;
3. The device biomechanics enables the dynamic which transmits the force to the maxilla to stimulate its advancement. This action/reaction force is mostly confined inside the device. This is summarized by a slight reaction retrusive force, loading on the mandible.
4. Thanks to the proprioceptive contact between the two sliding planes of the device, the TCR enables the orientation of the muscular and the condylar growth vectors. Considering that the main body of the device S&TCR does not invade the oral cavity, the TCR is one of the most valid therapeutical instruments to resolve the skeletal Class III in patients in growth age, even contemporarily at a myofunctional therapy. This situation portrays the innovation of the device: the possibility of using an orthopaedic device for the correction of the skeletal class and at the same time the performance of myofunctional and/or logopaedic therapies. All perfectly compatible with the use of orthodontic appliances (brackets, bands, etc.). Stimulating, then, for the orthodontist who can chose several therapeutical combinations, in order to satisfy all patients needs, shortening treatment times. The device results comfortable for the patient; after 4-7 days the patient adapts to it easily. The device, in its 2 variants (sectional 4-6 on the 4 quadrants; buccal splint from 6 to 6, upper and lower) is placed behind the coilspring, which is placed behind the Blockrun, in the lower part of the device. The mesial sliding of the stop enables the whole system advancement activating the device.



Before

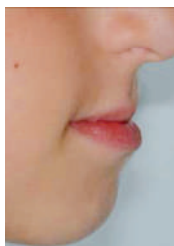



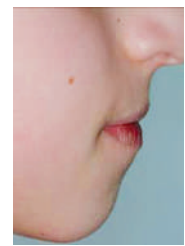



After



Laboratorio / *Laboratory*



Viti per espansione / Expansion screws





			Code	Packaging	
Standard		10	5 mm	1006-10	10 pcs
		14,3	7.5 mm	1006-14	10 pcs
Media / Medium		12	5 mm	1005-12	10 pcs
		14,3	6 mm	1005-14	10 pcs
Micro		10	4 mm	3005-7	10 pcs
		14	6 mm	3005-14	10 pcs

■ Merce disponibile / Goods available

■ Merce a richiesta / Goods on request



Viti per espansione / Expansion screws

			Code	Packaging
Nano 	 10	4 mm	2005-7	10 pcs
	 10	4 mm	2009 G	10 pcs



Micro



Medium

Viti monolaterali con guida a U U-shape guide monolateral screws



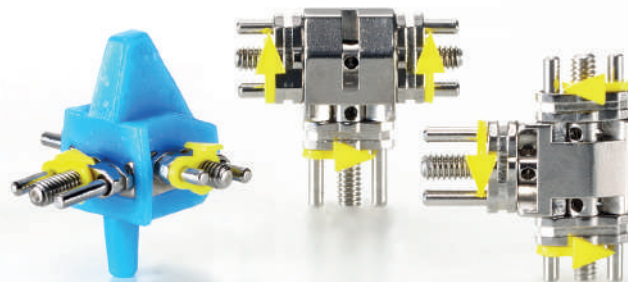

			Code	Packaging
Micro 2.8 6.2	11 	3 mm	3009 KG	10 pcs
	11,5 	3 mm	3009 KS	10 pcs
	11,5 	3 mm	3009 KSO	10 pcs
Media / Medium 7.5 3.5	13 	5 mm	1009 G	10 pcs
	13,5 	5 mm	1009 S	10 pcs
	13,5 	5 mm	1009 SO	10 pcs

■ Merce disponibile / Goods available

■ Merce a richiesta / Goods on request

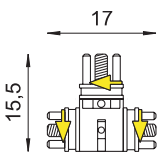

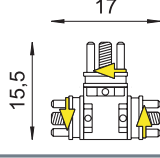
Viti tridirezionali / Tridirectional screws

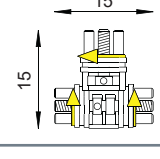
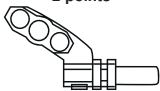
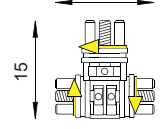
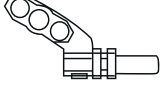
			Code	Packaging
	Attivazione / Activation 2 points 	Frontale / Frontal 5,5 mm	3026-2	1 pc
		Trasversale / Transversal 7 mm		
	Attivazione / Activation 3 points 	Frontale / Frontal 5,5 mm	3025-3	1 pc
		Trasversale / Transversal 2x3,5 mm		
	Attivazione / Activation 2 points 	Frontale / Frontal 5 mm	4016-2	1 pc
		Trasversale / Transversal 9 mm		
	Attivazione / Activation 3 points 	Frontale / Frontal 5 mm	4015-3	1 pc
		Trasversale / Transversal 2x4,5 mm		

■ Merce disponibile / Goods available

■ Merce a richiesta / Goods on request

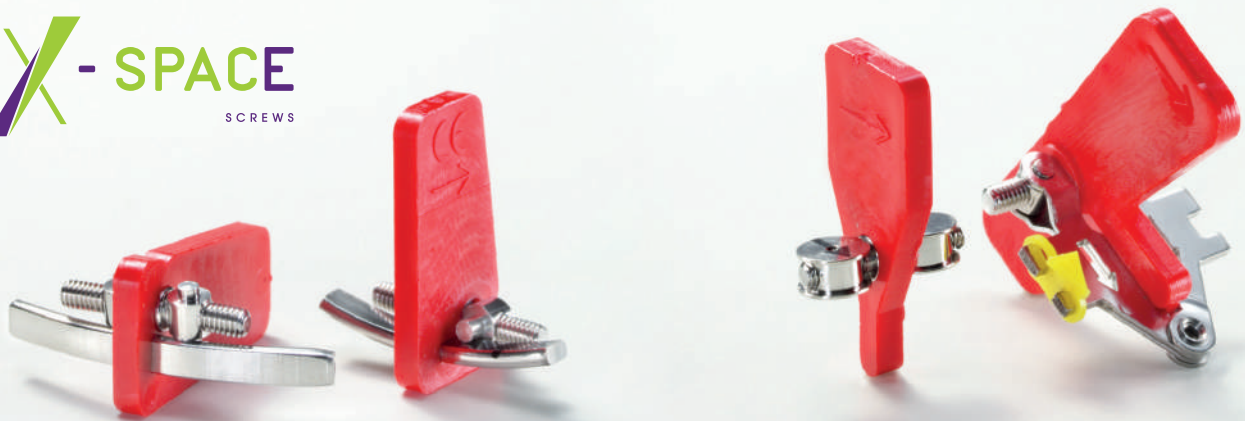

Viti a ventaglio / Fan-type screws

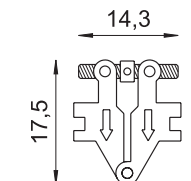
		Code	Packaging
	8 mm	1018 FA	1 pc



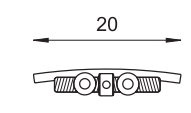

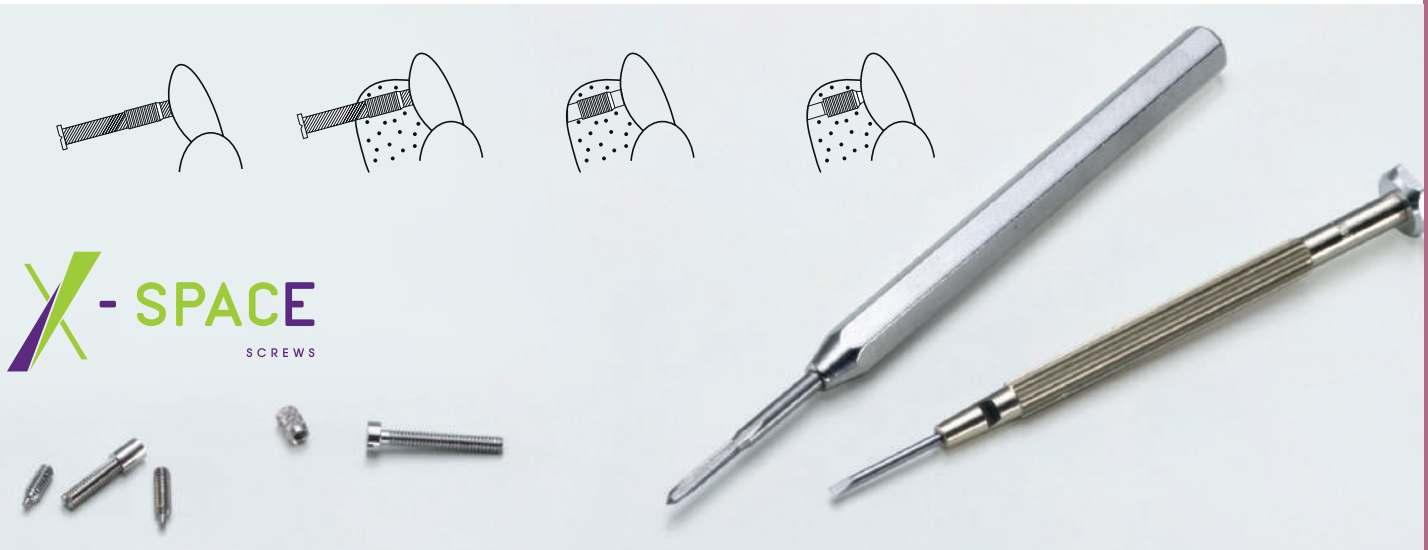

Viti ad arco per mandibola Mandibular bow screws

		Code	Packaging
	8 mm	1016	1 pc

■ Merce disponibile / Goods available
 ■ Merce a richiesta / Goods on request



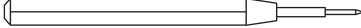

Micro viti / Micro screws

			Code	Packaging
	◀ 5.3 mm ▶	micro vite a molla <i>micro spring screw</i>	2004	10 pcs
	◀ 6.5 mm ▶	micro vite a molla <i>micro spring screw</i>	2006	10 pcs
	◀ 8.5 mm ▶	micro vite a molla <i>micro spring screw</i>	2008	10 pcs
	◀ 13 mm ▶	vite di montaggio <i>positioning screws</i>	2009	10 pcs
	◀ 3.3 mm ▶	bussola zigrinata per resina <i>serrated housing nut</i>	2010	10 pcs
		filettatore per vite a molla <i>spring screw reamer</i>	2012	1 pc
		cacciavite per microvite <i>screw driver</i>	2013	1 pc
STARTED KIT		Contiene / Includes: <ul style="list-style-type: none"> • 5 pcs x 2004/06/08/09 • 5 pcs x 2010 • 5 pcs x 2011 • 1 pc x 2012 • 1 pc x 2013 	2014	32 pcs

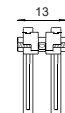

Viti per bite-jumping / Bite-jumping screws

		Code	Packaging	
Media / Medium		7 mm	4050 VDP	1 pcs
		6 mm	4060 UK	1 pcs

Tubo per extraorale / Extraoral tube

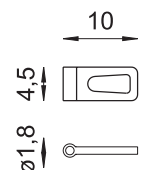
		Code	Packaging
	1,15 mm / .045"	315 AR	10 pcs

Chiavetta snodata di sicurezza / Swivel safety key



Swivel safety key	1080
10 pcs / pack	

■ Merce disponibile / Goods available
 ■ Merce a richiesta / Goods on request

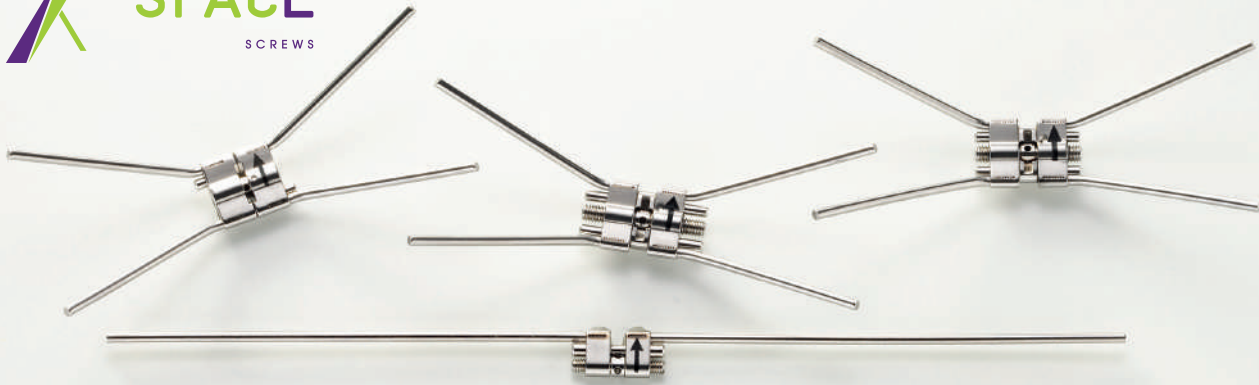

Braccetti saldati a laser
Laser-welded arms

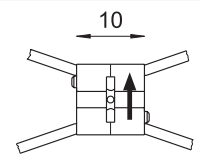
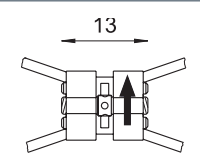
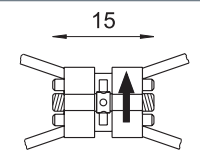
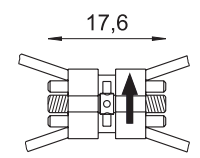
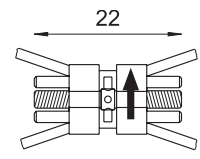
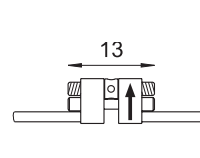
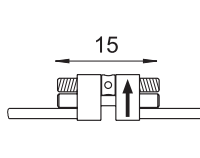
			Code	Packaging
Disgiuntore rapido Rapid expander		5 mm	1114-10	1 pc
		9 mm	1114-13	1 pc
		11 mm	1114-15	1 pc
		13 mm	1114-17	1 pc
		18 mm	1114-22	1 pc
Disgiuntore inferiore Expander for lower arch		9 mm	1214-13	1 pc
		11 mm	1214-15	1 pc



■ Merce disponibile / Goods available
 ■ Merce a richiesta / Goods on request

Bite occlusali / Occlusal bite

I bite occlusali vengono utilizzati nelle terapie di I^a, II^a e III^a classe, per allineare e correggere le arcate superiori ed inferiori, dando un buon allineamento e livellamento globale.

Occlusal bite are useful in class I^a, II^a e III^a therapies, to align and correct upper and lower arches. The result will be a good alignment and a total leveling.

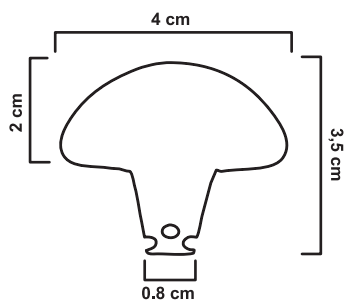

Posterior left

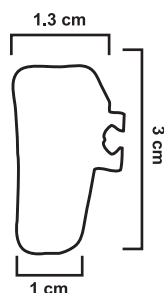

Posterior right



Occlusal bite

Anteriore / Anterior	5000-01
Posteriore destro / Posterior right	5000-02
Posteriore sinistro / Posterior left	5000-03
3 pcs / pack	



■ Merce disponibile / Goods available

■ Merce a richiesta / Goods on request

Filo per ganci / Clasp Wire

Filo per ganci, realizzato con acciaio di tipo medicale e trafilato al diamante; si distingue per l'inalterabilità nel cavo orale, l'elevata elasticità e la resistenza. Il Filo possiede tutti i requisiti qualitativi richiesti in ortodonzia e in protesi, offrendo all'operatore risultati di elevata qualità.

These dental wires are made from high strength medical stainless steel. Diamond finished wires, that offer the professional high quality results, thanks to their resistance and elasticity characteristics.



Clasp wire 1800/2000 N/mm²

	m	inch	mm
STS400-05	50	.020	0,5
STS400-06	40	.024	0,6
STS400-07	30	.028	0,7
STS400-08	20	.032	0,8
STS400-09	10	.036	0,9
STS400-10	10	.040	1,0
STS400-11	10	.044	1,1
STS400-12	10	.048	1,2
Spool			

	g	inch	mm
STS450-05	500	.020	0,5
STS450-06	500	.024	0,6
STS450-07	500	.028	0,7
STS450-08	500	.032	0,8
STS450-09	500	.036	0,9
STS450-10	500	.040	1,0
STS450-11	500	.044	1,1
STS450-12	500	.048	1,2
Spool			

Ganci a palla / Ball hooks

I ganci a Palla sono eccellenti accessori per applicazioni removibili prodotti in acciaio inossidabile. Confezione da 100pz.

Ball hooks are excellent accessories for removable and fixed appliances. Stainless Steel, 100 pcs / pack.

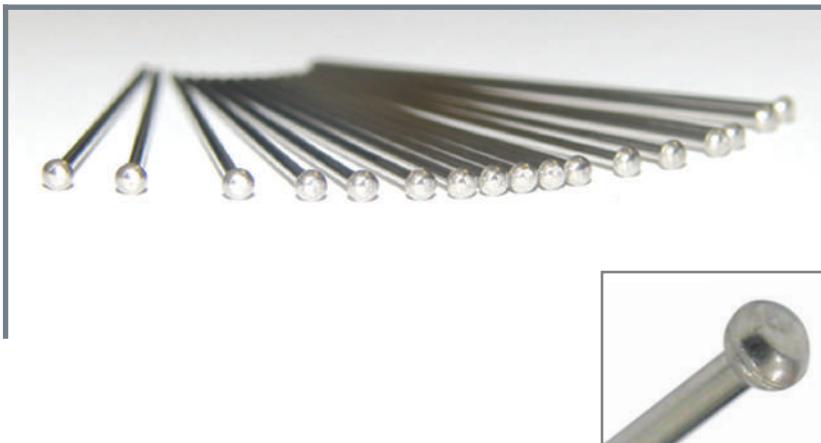

Ball hooks

	inch	mm
SSBC024	.024	0,6
SSBC028	.028	0,7
SSBC032	.032	0,8
SSBC036	.036	0,9
SSBC040	.040	1,0
100 pcs / pack		

■ Merce disponibile / Goods available

■ Merce a richiesta / Goods on request

Saldatura in argento / Silver Solder

La saldatura in argento è un prodotto specifico per saldature in campo odontoiatrico, disponibile in spoletta da .031 / 0.79 mm, lunghezza 1.90 m e peso 8g.

Specific product for dental applications, spool .031 / .079 mm, 1.90 m lenght, 8g weight.



Saldatura in argento

Silver solder	SLVSLD
Spool	

Ultra Flux

Ultra Flux pasta per saldatura, 50g.

Solder paste, 50g.



Ultra Flux	75013
1 pc / pack	

Resina ortodontica autopolimerizzante Self curing orthodontic resin

Resina a freddo per uso ortodontico, indicata per la costruzione di placche.

Si consiglia l'uso di idromuffola o pentola a pressione 2 - 2,5 bar.

Self curing orthodontic resin usefull for dental plaques creation. Hydroflask or pressure pot 2-2,5 bar recommended.



Kit

500 g + 250 ml	00990004
2 pcs / pack	

Ricambio / Refill

Powder - 1000 g	02-016P
Liquid - 500 ml	02-016L
1 pc / pack	

■ Merce disponibile / Goods available

■ Merce a richiesta / Goods on request

Pomice extra fine / Extra fine pumice

Pomice naturale per la lucidatura di manufatti protesici. Fusto da 5 kg.

Natural pumice for the polishing of dental prosthesis. 5 kg plastic drum



Extra fine Pumice	00280030
5 kg plastic drum	

Dabliu Stone tipo III ortodontico Gypsum: type III, for the orthodontic field

Dabliu Stone gesso di tipo III, per modelli ortodontici di alta qualità. Colore bianco.

Dabliu Stone gypsum, type III, for high quality orthodontic models. White colour.



Fusto da 15 kg / 15 kg bin

Dabliu Stone orthodontic gypsum type III	00280026
--	----------

Fusto da 5 kg / 5 kg bin

Dabliu Stone orthodontic gypsum type III	00280027
--	----------

Dabliu Stone tipo IV extra duro ortodontico Gypsum: type IV, extra hard, for the orthodontic field

Dabliu Stone gesso di tipo IV extraduro, per modelli ortodontici di alta qualità. Colore bianco, fusto da 5 kg.

Dabliu Stone extra hard gypsum, type IV, recommended for high quality orthodontic models. White colour, 5 kg plastic drum



Fusto da 15 kg / 15 kg bin

Dabliu Stone orthodontic gypsum type IV	00280028
---	----------

Fusto da 5 kg / 5 kg bin

Dabliu Stone orthodontic gypsum type IV	00280017
---	----------

■ Merce disponibile / Goods available
■ Merce a richiesta / Goods on request

Ortho Form placche termoplastiche / Thermoforming plates

Ortho Form sono dischi termoplastici rigidi e morbidi, per qualsiasi tipo di lavorazione come mascherine per sbiancamento, bite per bruxismo, applicazioni per ATM, mascherine di contenzione, etc. Disponibile nelle misure: 125 x 125 mm , Ø 120 mm, Ø 125 mm, Ø 134 mm.

Ortho Form hard and soft thermoforming plates, recommended for any kind of working, such as bleaching masks, bite for bruxism, ATM applications, contention masks etc. Available in: 125 x 125 mm, Ø 120 mm, Ø 125 mm, Ø 134 mm.

Indicazioni / Directions

Riportiamo di seguito alcune indicazioni al fine di ottenere una termoformatura ottimale

In order to obtain an excellent thermoforming process, as follow some advices:

- per i modelli si consiglia l'utilizzo di un gesso di III^a classe;
The use of a 3rd class gypsum is recommended for models;
- evitare l'utilizzo di gessi troppo duri (causerebbero la rottura del modello in fase di distacco);
the use of excessively hard gypsums is not recommended (they may cause the break of the model during the separation step);
- per ottenere un buon dettaglio il gesso deve avere un'ottima permeabilità all'aria;
to obtain a great detail, the gypsum must have an excellent permeability to air;
- il modello in gesso non dev'essere assolutamente bagnato, al massimo può essere umido;
the gypsum model mustn't be absolutely wet, but at most only damp;
- in caso di modelli alti, si consiglia di ridurli con una squadramodelli, o immergerli in sfere di acciaio in modo da far fuoriuscire solo la parte da termoformare;
in case of high models, it's better to make a reduction with a melting machine, or put them in steel spheres to facilitate the leak of the thermoforming section;
- eliminare eventuali bolle causate dalla colatura del gesso;
remove possible bubbles caused by the trickle of the gypsum;
- valutare le caratteristiche tecniche / fisiche dei fogli termoplastici prima dell'utilizzo.
evaluate the technical / physical features of the thermoforming plates before their use.

REF 00XXXXR



Ø 120 mm

REF 00XXXXRB



Ø 134 mm



REF 00XXXXRS



Ø 125 mm

REF 00XXXX



125 x 125 mm

■ Merce disponibile / Goods available

■ Merce a richiesta / Goods on request

Soft Form

Etilenvinilacetato (EVA), indicato per mascherine di sbiancamento, patologie ATM, fluoro profilassi, docce morbide per Bruxismo.

Eva material, recommended for bleaching masks, ATM pathologies, fluoride prophylaxis, Bruxism.

	Pack	SQUARE	ROUND Ø120	ROUND Ø125	ROUND Ø134
1,0 mm	24 pcs	001817	001817R	001817RS	001817RB
1,5 mm	20 pcs	001835	001835R	001835RS	001835RB
2,0 mm	20 pcs	001836	001836R	001836RS	001836RB
3,0 mm	10 pcs	001837	001837R	001837RS	001837RB
4,0 mm	10 pcs	001838	001838R	001838RS	001838RB

Dura Form

Polietilene tereftalato, indicato per matrici provvisorie, docce dure per Bruxismo e sbiancamento, cucchiai chirurgici e applicazioni in ortodonzia.

Polyethylene terephthalate recommended for temporary matrix, Bruxism and bleaching bites, surgical tray and orthodontic appliances.

	Pack	SQUARE	ROUND Ø120	ROUND Ø125	ROUND Ø134
0,5 mm	24 pcs	001828	001828R	001828RS	001828RB
0,8 mm	24 pcs	001827	001827R	001827RS	001827RB
1,0 mm	24 pcs	001823	001823R	001823RS	001823RB
1,5 mm	20 pcs	001824	001824R	001824RS	001824RB
2,0 mm	15 pcs	001826	001826R	001826RS	001826RB
3,0 mm	10 pcs	001833	001833R	001833RS	001833RB

Dual Form

Placca a due strati, strato duro SBS e strato morbido EVA. Consigliata per docce rigide per Bruxismo, patologie ATM ed applicazioni in ortodonzia.

Plate with two layers, SBS hard layer and EVA soft layer. Suitable for Bruxism, ATM pathologies orthodontic appliances.

	Pack	SQUARE	ROUND Ø120	ROUND Ø125	ROUND Ø134
2 mm	10 pcs	001943	001943R	-	-
3 mm	10 pcs	001939	001939R	-	-

Base Plate Form

Stirene ad alta compressione. Indicato per cucchiai per montaggi in protesi totale e supporti rinforzati per valli di cera (masticoni).

High compression styrene. Recommended for trays and reinforced supports to fit complete dentures.

	Pack	SQUARE	ROUND Ø120	ROUND Ø125	ROUND Ø134
1,5 mm	24 pcs	001819	001819R	-	-
2,0 mm	20 pcs	001818	001818R	-	-
2,5 mm	10 pcs	001820	001820R	-	-

Coping Form

Polipropilene opaco, indicato per ponti e corone provvisorie, cappette calcinabili.

Opaque polypropylene suitable for temporary bridges and crowns, castable copings.

	Pack	SQUARE	ROUND Ø120	ROUND Ø125	ROUND Ø134
0,5 mm	24 pcs	001830	001830R	-	-
0,8 mm	24 pcs	001831	001831R	-	-
1,0 mm	24 pcs	001832	001832R	-	-

Tray Form

Stirene ad alta compressione. Indicato per portaimpronte individuali.

High compression styrene. Recommended for individual impression trays.

	Pack	SQUARE	ROUND Ø120	ROUND Ø125	ROUND Ø134
3 mm	10 pcs	001822	001822R	-	-

■ Merce disponibile / Goods available

■ Merce a richiesta / Goods on request

Buste porta lavori / Ziplock plastic bags

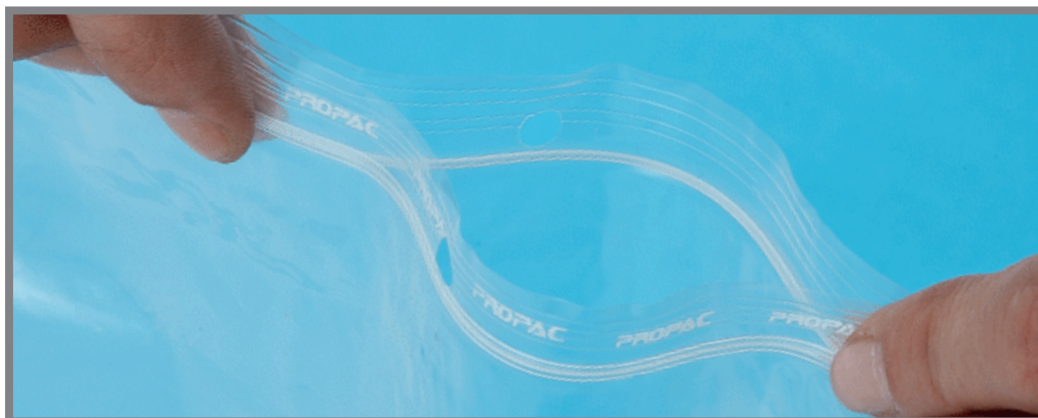

Chiusura a pressione / Ziplock plastic bag

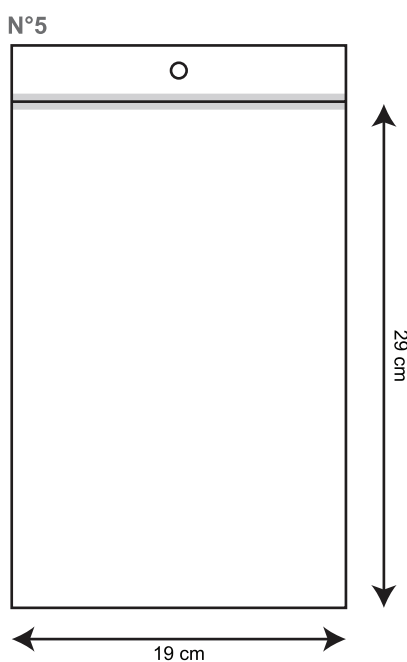
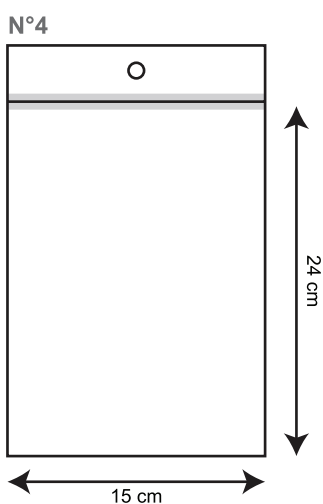
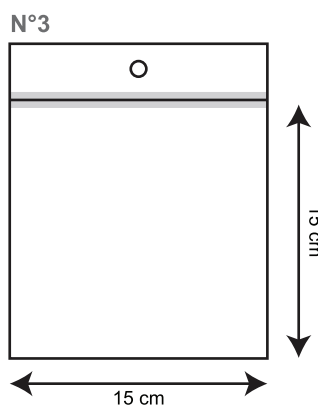
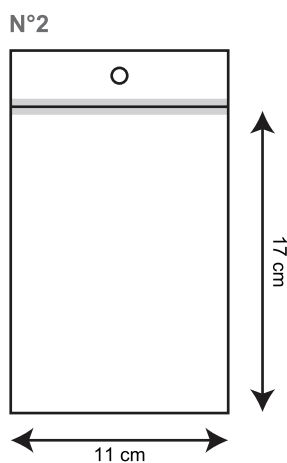
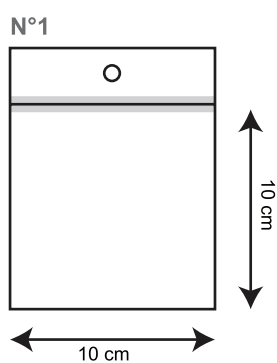

Ziplock plastic bags

N°1	BS1010
N°2	BS1117
N°3	BS1515
N°4	BS1524
N°5	BS1929
100 pcs / pack	

■ Merce disponibile / Goods available

■ Merce a richiesta / Goods on request

Pinze e Strumenti / *Pliers and Instruments*



Perfect Line PL-001 inserti TC

Tronchese Miniature per legature Ø max .014"
Miniature Cutter TC insert light ligature and wire Ø max .014"



Perfect Line PL-020 inserti TC

Tronchese per legature Ø max .020"
Ligature cutter TC insert hard wire Ø max .020"

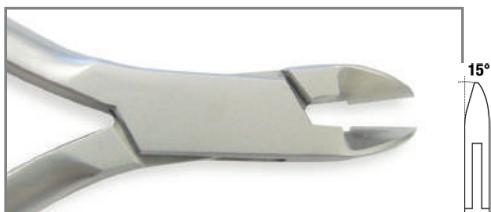

Perfect Line PL-002 inserti TC

Tronchese Miniature per legature Ø max .014", angolata 15°
Miniature Cutter TC insert light ligature and wire Ø max .014", angled 15°



Perfect Line PL-040 inserti TC

Tronchese Distale con trattenuta filo Ø max .021" x .025"
Distal end cutter, safety hold TC Ø max .021" x .025"

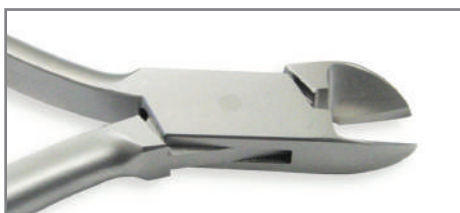

Perfect Line PL-010 inserti TC

Tronchese per filo duro Ø max .028"
Hard wire cutter TC with cut angle Ø max .028"



Perfect Line PL-045 inserti TC

Tronchese Distale con trattenuta filo **MANICO LUNGO** Ø max .021"x.025"
Distal end cutter safety hold TC Ø max .021"x.025" **LONG HANDLE**



Perfect Line PL-011 inserti TC

Tronchese per filo duro Ø max .028", angolata 15°
Hard wire cutter TC with cut angle Ø max .028", angled 15°



Perfect Line PL-080

Pinza di Adams Ø max .028"
Adam's plier Ø max .028"



Perfect Line PL-015

Tronchese Heavy-Duty Cutter Ø max .042"
Heavy-Duty cutter hard wire Ø max .042"



Perfect Line PL-090

Pinza Angle a becco di uccello **CORTA**, Ø max .028"
Bird Beak plier Angle **SHORT**, Ø max .028"

■ Merce disponibile / Goods available

■ Merce a richiesta / Goods on request



Perfect Line PL-100

Pinza Angle a becco di uccello **LUNGA**, Ø max .028"
Bird Beak plier Angle LONG, Ø max .028"



Perfect Line PL-145

Pinza di Aderer a 3 becchi Ø max .024", **PUNTA CORTA**
Aderer plier 3 beaks SHORT TIP, Ø max .024"



Perfect Line PL-110

Pinza a becco di uccello Ø max 0.24"
Bird Beak plier Ø max 0.24"

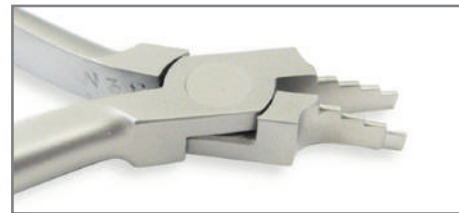

Perfect Line PL-150

Pinza di Nance Ø max .028"
Nance plier Ø max .028"



Perfect Line PL-120

Pinza a becco di uccello **CORTA**, Ø max .028"
Bird Beak plier SHORT, Ø max .028"



Perfect Line PL-160

Pinza Tweed, Ø max .021" x .028" **PUNTA LUNGA**
Tweed plier LONG TIP, Ø max .021" x .028"



Perfect Line PL-125

Pinza concava / convessa a becchi stretti Ø max .016"
Concave / convex plier with narrow beaks Ø max .016"



Perfect Line PL-165

Pinza Tweed, Ø max .021" x .028" **PUNTA CORTA**
Tweed plier SHORT TIP, Ø max .021" x .028"



Perfect Line PL-140

Pinza di Aderer a 3 becchi Ø max .024" (mm 120), **PUNTA LUNGA**
Aderer plier 3 beaks LONG TIP, Ø max .024" (mm 120)



Perfect Line PL-170

Pinza per archi linguali Ø max .028"
Lingual arch plier Ø max .028"

■ Merce disponibile / Goods available
■ Merce a richiesta / Goods on request



Perfect Line PL-175

Pinza di Nance per formare ganci di Adams e piccoli stop da laboratorio
Laboratory Adams clasp forming plier Nance style



Perfect Line PL-220

Pinza togli brackets, **PUNTA STRETTA**
Brackets remover plier, NARROW TIP



Perfect Line PL-180

Pinza De la Rosa concava / convessa, Ø max .020"
BECCO CON SCANALATURE
De la Rosa plier concave / convex, Ø max .020"



Perfect Line PL-225

Pinza togli brackets **CURVA**
Brackets remover plier CURVED



Perfect Line PL-190

Pinza De la Rosa concava / convessa, Ø max .020" **BECCO LISCIO**
De la Rosa plier concave / convex smooth beaks Ø max .020"



Perfect Line PL-250

Pinza Weingart Ø max .020"
Weingart plier Ø max .020"

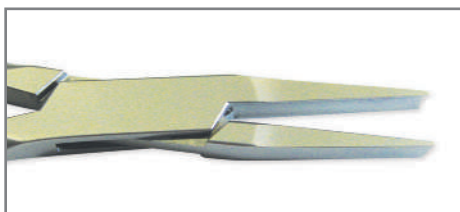

Perfect Line PL-195

Pinza di Hollow Chop, concava / convessa
Concave / convex, Hollow Chop Plier



Perfect Line PL-265

Pinza di How curva Ø max .028", **PUNTA CORTA**
How curved plier SHORT TIP, Ø max .028"



Perfect Line PL-200

Pinza togli bande
Band remover plier with pads



Perfect Line PL-275

Pinza di How dritta Ø max .028", **PUNTA CORTA**
How straight plier SHORT TIP, Ø max .028"

■ Merce disponibile / Goods available

■ Merce a richiesta / Goods on request

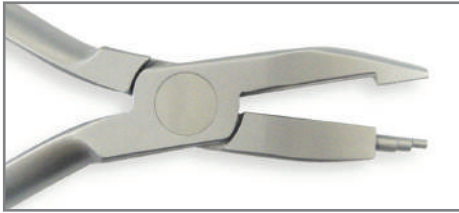

Perfect Line PL-290

Pinza per Omega Loop Ø max .028"
Omega Loop plier Ø max .028"



Perfect Line PL-360

Pinza per separatori
Separator plier



Perfect Line PL-300

Pinzetta di Young Ø max .020"
Young plier Ø max .020"



Perfect Line PL-355

Pinza per tubi convertibili
Tubes convertible pliers



Perfect Line PL-330

Pinza per formare angoli retti su fili in nickel titanio e acciaio Ø max .028"
Plier for right angles (Ni-Ti and steel wires) Ø max .028"



Perfect Line PL-510

Pinza Universale
Universal plier (classic)



Perfect Line PL-340

Pinza Jarabak Ø max .024"
Jarabak plier Ø max .024"

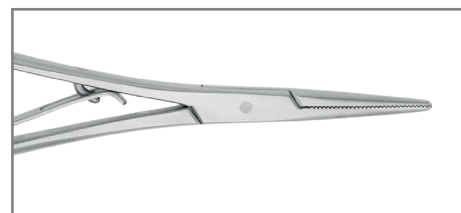

Perfect Line PL-580

Pinza di Mathieu per legature - **PUNTA STRETTA**
Mathieu ligature positioner - NARROW TIP



Perfect Line PL-350

Pinza per formare stop a "V", Ø max .024"
Plier for "V" stop Ø max .024"



Perfect Line PL-585

Pinza di Mathieu per legature - **PUNTA LARGA**
Mathieu ligature positioner - LARGE TIP



- Merce disponibile / Goods available
- Merce a richiesta / Goods on request

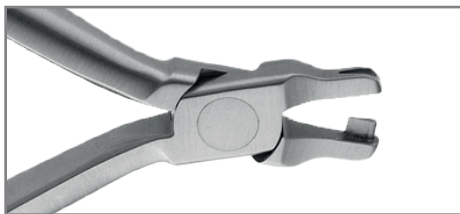

Perfect Line PL-600 per allineatori

Pinza a taglio lacrima
Tear drop plier



Perfect Line PL-640

Pinzetta dritta per attacchi
Brackets straight plier

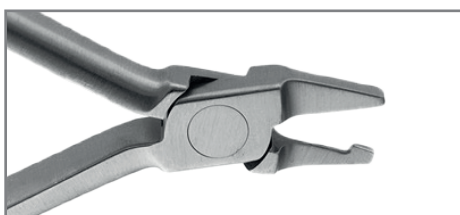

Perfect Line PL-605 per allineatori

Pinza a taglio verticale
Vertical plier



Perfect Line PL-650

Mosquito
Mosquito Hemostat

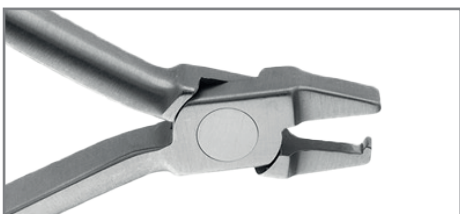

Perfect Line PL-610 per allineatori

Pinza a taglio orizzontale
Horizontal plier



Perfect Line PL-660

Pinzetta per posizionare tubi
Tubes positioner plier

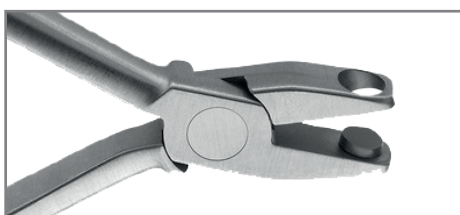

Perfect Line PL-615 per allineatori

Pinza a taglio tondo
Hole punch plier



Perfect Line PL-680

Applicatore per legature elastiche
Elastic ligatures positioner



Perfect Line PL-633

Pinza per Grippare ganci chirurgici
Surgical hook Crimping Plier



Perfect Line PL-690

Strumento di utilità
Utility instrument

■ Merce disponibile / Goods available
■ Merce a richiesta / Goods on request

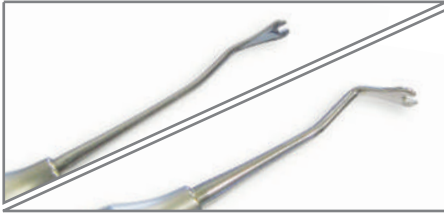

Perfect Line PL-700

Direzionatore per legature
Orthodontic instrument for ligatures

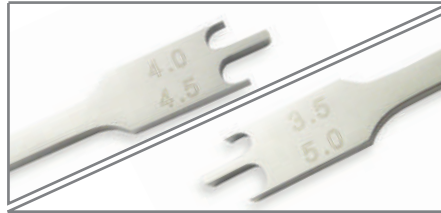

Perfect Line PL-780 / PL-785

Altimetro per brackets (Alluminio) / *Altimeter for brackets (Alluminium)*
Ø max .018" (PL-780) - Ø max .022" (PL-785)



Perfect Line PL-740

Altimetro per brackets
Brackets altimeter



Perfect Line PL-790

Strumento per posizionare brackets e tubi
Posterior bond placer



Perfect Line PL-750

Spingibande - Sterilizzabile a caldo
Heat sterilizable band carrier



Perfect Line PL-810

Calibro Digitale
Digital Gauge



Perfect Line PL-755

Spingibande - Sterilizzabile a caldo, (puno di contatto in teflon)
Heat sterilizable band carrier, (Teflon contact point)



Perfect Line PL-830

Strumento per rimuovere allineatori
Aligner remover



Perfect Line PL-370

Strumento per la piegatura distale degli archi Ø max .022"
Distal plier for arches Ø max .022"
■ Merce disponibile / Goods available
■ Merce a richiesta / Goods on request



Perfect Line PL-860

Calibro interprossimale (0,10 - 0,20 - 0,25 - 0,30 - 0,40 - 0,50 mm)
Interproximal gauge (0,10 - 0,20 - 0,25 - 0,30 - 0,40 - 0,50 mm)

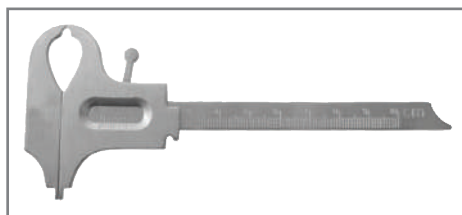

Perfect Line PL-870

Calibro Boley
Boley Gauge

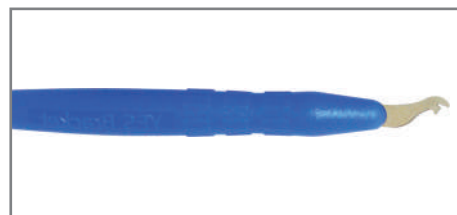

Strumento per brackets - 110-000

Strumento per attacchi self-ligating
Tool for self-ligating brackets

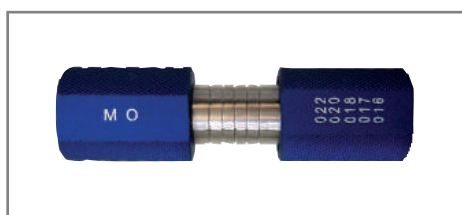

Perfect Line AFTR200

Torretta per formare archi, Torque O
Arch forming Turret, without Torque



Perfect Line ZDGL10

Altimetro con graffite, misure 3.5 - 4 - 4.5 - 5 mm
Zand Gauge, measures 3.5 - 4 - 4.5 - 5 mm

Contrangolo 4:1 - "Twist"

Il contrangolo con rapporto 4:1, caratterizzato da un movimento oscillante, è specificamente progettato per l'utilizzo nelle procedure di stripping in ortodonzia e conservativa.

Archetti montati con strisce diamantate su entrambi i lati, con fori:

- **REF: 1400030-15HD** - 15 øm - 15 HD - 0,17 mm (1 pz.);
- **REF: 1400030-25HD** - 25 øm - 25 HD - 0,19 mm (1 pz.);
- **REF: 1400030-40HD** - 40 øm - 40 HD - 0,23 mm (1 pz.);
- **REF: 1400030-60HD** - 60 øm - 60 HD - 0,32 mm (1 pz.);
- **REF: 1400030-90HD** - 90 øm - 90 HD - 0,40 mm (1 pz.).

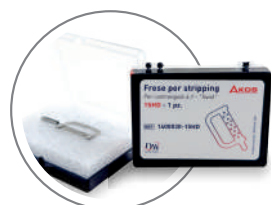

Packaging:

- Contrangolo;
- 1 contrangolo twist 4:1.

Kit:

- 1 contrangolo twist 4:1;
- 10 archetti;
- 1 supporto per utilizzo manuale;
- 1 strumento per la rimozione degli archetti;
- 1 spessimetro;
- 2 strisce diamantate.

Parametri tecnici:

- Rumorosità: ≤ 58 dB;
- Velocità massima: 10.000 RPM;
- Temperatura di lavoro: ≤ 20°C;



Testa oscillante - Cieco
cod. **1400031**



Kit "Twist"
cod. **1400030**



■ Merce disponibile / *Goods available*
■ Merce a richiesta / *Goods on request*

Attrezzatura / *Equipment*

Easy Form Evolution

Termoformatrice automatica / Automatic Thermoforming machine

La Evolution è una termoformatrice con processo di termoformatura completamente automatico.

Il processo viene assicurato mediante l'impostazione del tempo in funzione della tipologia del foglio utilizzato e del suo spessore.

Evolution is an automatic thermoforming machine. The automatic process is assured by setting the time according to the type of sheet used and its thickness.

Caratteristiche / Characteristics

- Display digitale
LCD display
- Controllo a microprocessore SMD
SMD technology
- Tempi impostabili (da 15" a 7")
Setting times (from 15" to 7")
- Resistenza 350 Watt
Resistance 350 watts
- Pompa del vuoto integrata con pistone
Vacuum pump with piston included
- Pressione massima 250 mbar
Maximum pressure 250 mbar
- Rumorosità 56 dB
Noise level 56 dB

Vantaggi / Advantages

- Processo di termoformatura completamente automatico
Fully automatic thermoforming process
- Possibilità di utilizzo dischi quadrati o tondi da 120 a 125 mm
Possibility of using square or round sheets from 120 to 125 mm
- Non necessita di aria compressa o fonti esterne di aria per aspirazione
Compressed air or external sources of suction air not required

Packaging

- Termoformatrice: 1 pz
Thermoforming machine: 1 pcs
- Cestello porta sfere: 1 pz
Spheres basket: 1 pcs
- Cestello di dettaglio: 1 pz
Detail basket: 1 pcs
- Cavo di alimentazione: 1 pz
Power cable: 1 pcs
- Libretto istruzioni
Instruction for use



Easy Form Evolution	00340720
Spheres Ø 0,40 mm - 1 bag	001040
Spheres Ø 0,28 mm - 1 bag	001041

■ Merce disponibile / Goods available

■ Merce a richiesta / Goods on request

Easy Form Aspy

Termoformatrice manuale / Manual thermoforming machine

La Aspy è una termoformatrice manuale che consente all'operatore di gestire manualmente le fasi di termoformatura. L'operatore aziona la resistenza mediante l'apposito pulsante ed una volta riscaldato il foglio termoformabile in maniera appropriata, può procedere azionando la pompa del vuoto.

Aspy is a manual thermoforming machine which allows the operator to manually manage the thermoforming steps. The operator activates the resistance by a specific button and, once the thermoforming sheet is appropriately heated, he can proceed by activating the vacuum pump.

Caratteristiche / Characteristics

- Resistenza 350 Watt
Resistance 350 Watt
- Pompa del vuoto integrata con pistone
Vacuum pump with piston included
- Pressione massima 250 mbar
Maximum pressure 250 mbar
- Rumorosità 56 dB
Noise level 56 dB

Vantaggi / Advantages

- Possibilità di utilizzo di dischi quadrati o tondi da 120 a 125 mm
Possibility of using square or round sheets from 120 to 125mm
- Non necessita di aria compressa o fonti esterne di aria per aspirazione
Compressed air or external sources of suction air not required

Packaging

- Termoformatrice: 1 pz
Thermoforming machine : 1 pcs
- Cestello porta sfere: 1 pz
Spheres basket: 1 pcs
- Cestello di dettaglio: 1 pz
Detail basket: 1 pcs
- Cavo di alimentazione: 1 pz
Power cable: 1 pcs
- Libretto istruzioni
Instruction for use



Easy Form Aspy	00340080
Spheres Ø 0,40 mm - 1 bag	001040
Spheres Ø 0,28 mm - 1 bag	001041

Puntatrice HL-WDII / Welding machine HL-WDII

La Puntatrice HL-WDII è un apparecchio estremamente versatile, grazie alle sue caratteristiche e alle sue dimensioni contenute. La HL-WDII può essere impiegata per PUNTATURA, BRASATURA, PUNTATURA A FREQUENZA, TRATTAMENTO TERMICO DI ACCIAI. Con il display digitale si evincono tutte le informazioni di impostazione e parametri. Dotata di 4 elettrodi superiori ed inferiori, ruotabili a 360° per avere tutte le combinazioni possibili per una corretta puntatura.

A very versatile machine, thanks to its characteristics and dimensions. It can be used for welding, braze welding, frequency welding, stainless steel wire heat treatment. Endowed of 4 upper and lower 360° rotatable electrodes, to get all possible combinations for a correct welding.



Puntatrice

Welder machine	HL-WDII
1 pc / pack	

Pentola a pressione / Pressure pot

Pentola a pressione per la polimerizzazione delle resine a freddo. Capienza 5 lt / Dimensione interna: altezza 14 cm - Ø 22 cm
Pressure pot used to cure cold resin. Capacity: 5lt / Internal dimension: height 14 cm - Ø 22 cm



Pentola a pressione

Pressure pot	160.000
1 pc / pack	

Negativoscopio da tavolo LED / LED tabletop negatoscope

Negativoscopio da tavolo a LED. Dimensioni: 432 mm x 304 mm x 102 mm. Indicato per cefalometrie e panoramiche.
LED tabletop negatoscope. Size: 432 mm x 304 mm x 102 mm. Indicated for cephalometric and panoramic radiographs.



Negativoscopio

Negatoscope	7080740
1 pc / pack	

■ Merce disponibile / Goods available

■ Merce a richiesta / Goods on request

Grafici delle forze degli archi

Force value Graphs of archwires

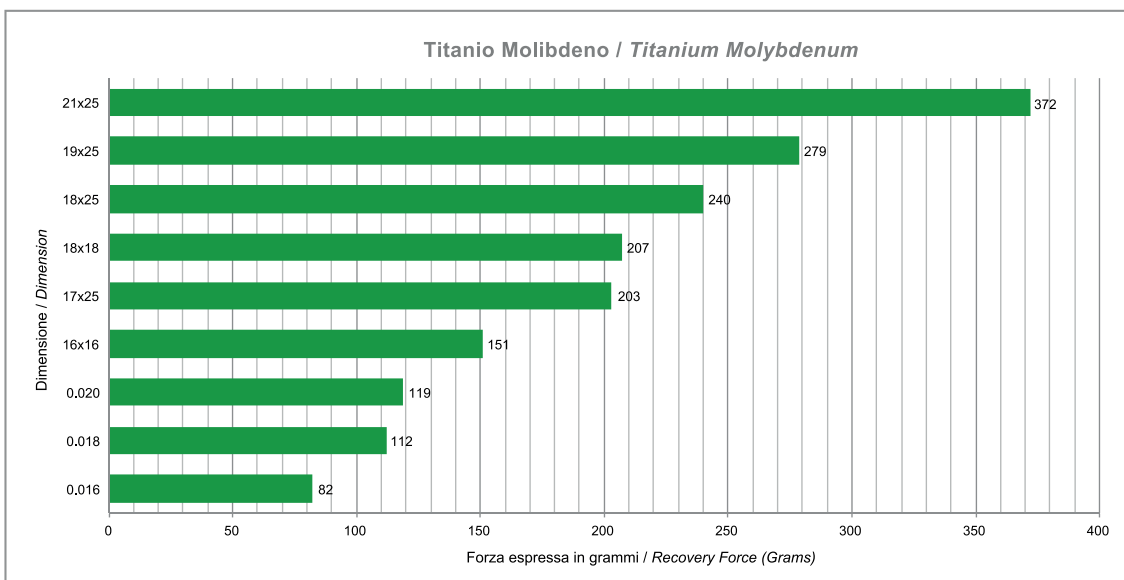
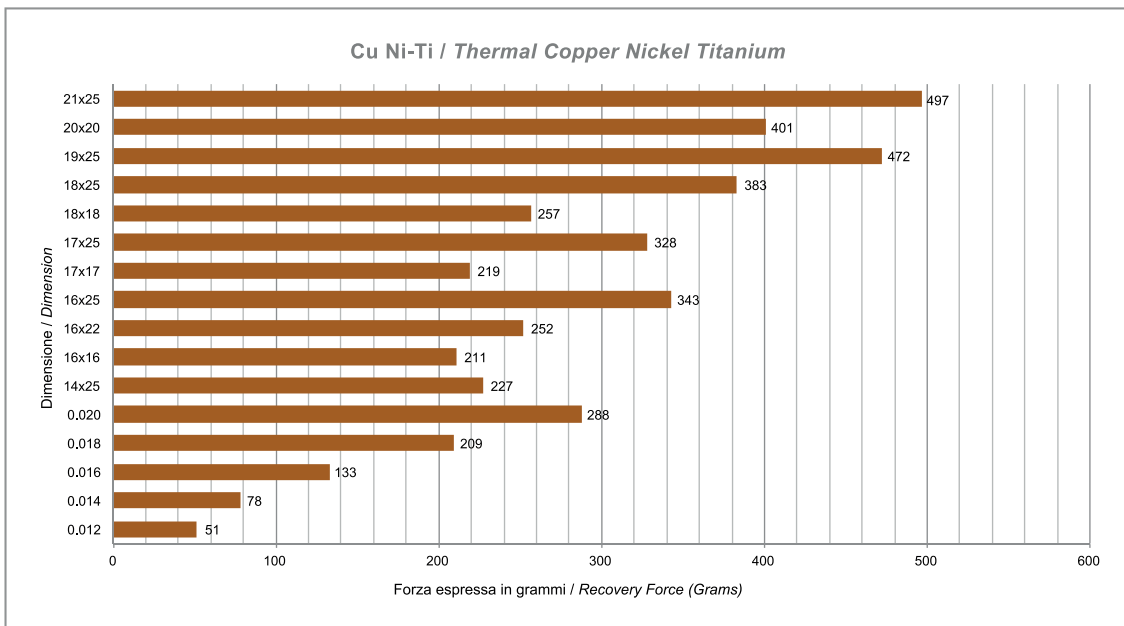
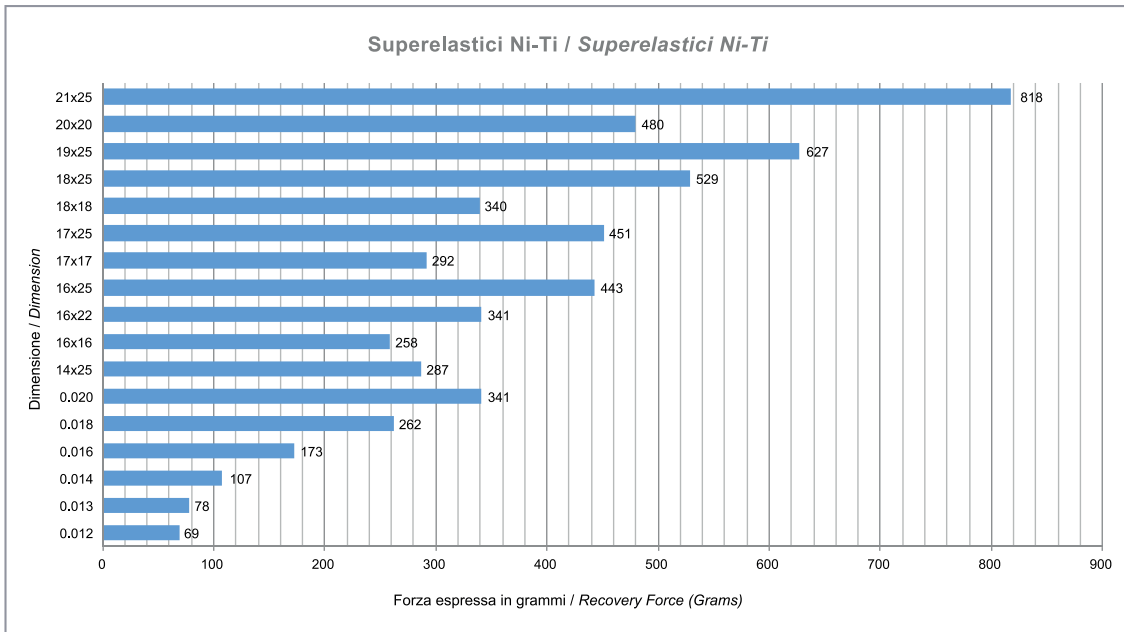

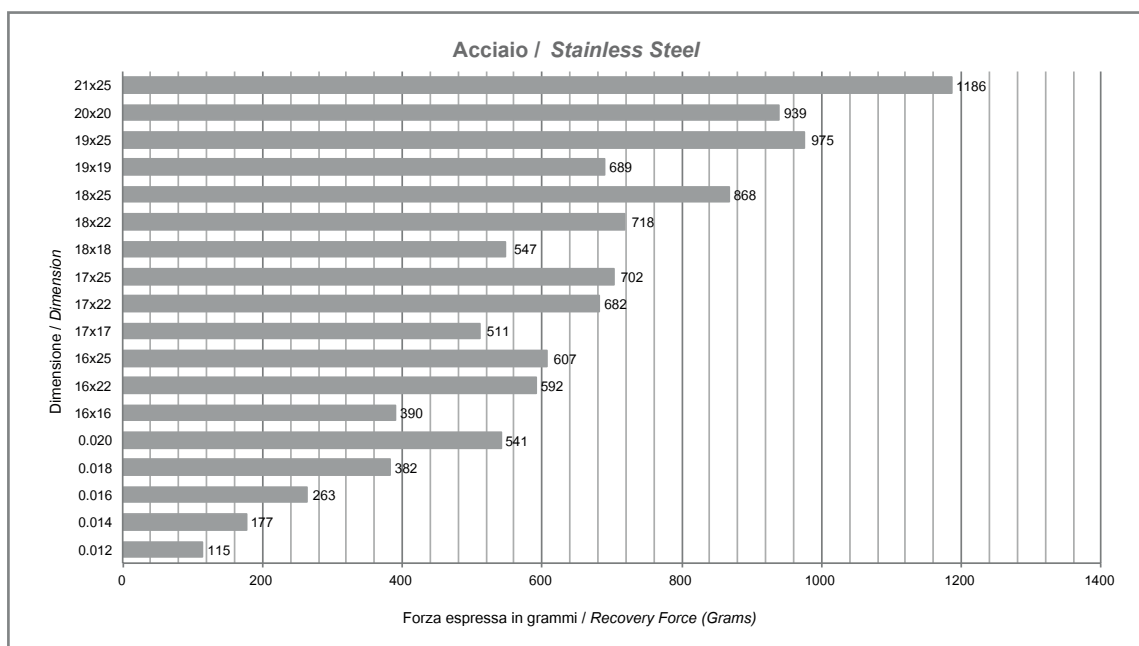
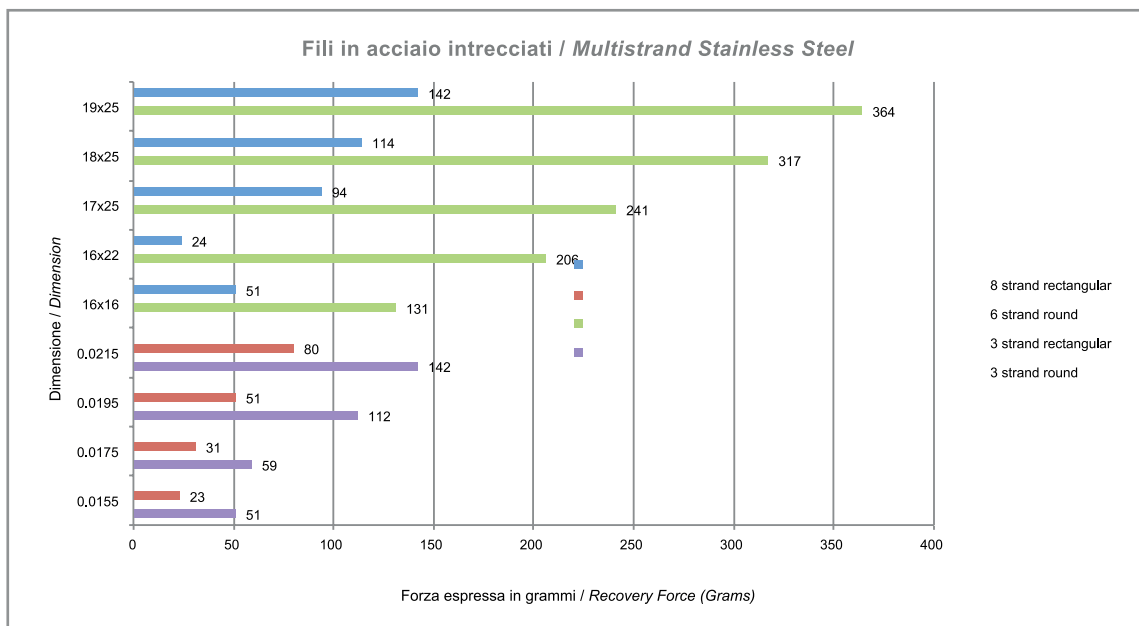

Forme archi / *Archwires' shape*

Tutti gli archi vengono contrassegnati nella parte mediana in maniera permanente, con tre linee per i superiori e una linea per gli inferiori, ad esclusione degli archi in filo Australiano ed estetico, che sono marcati ad inchiostro (e quindi removibile) nella linea mediana, nero per i superiori, rosso per gli inferiori.

All arches are midline-etched for permanent identification, three lines for the upper arches and one line for the lower ones, Australian and aesthetic arches are ink-midline marked only (removable), black ink for the upper arches and red ink for the lower ones.

Imbustamento Archi (solo-pack) / *Archwires' packaging (solo-pack)*

Aggiungendo la "S" alla fine del codice, gli archi saranno imbustati singolarmente.

By adding "S" at the end of the item code, the arches will be individually packed.

Ansa Mediana - Dimpled / *Dimpled Midline*

Archi con ansa mediana per evitare scorrimenti laterali. Disponibili su richiesta, aggiungendo (D) alla fine del codice.

Arches with middle dimple to avoid lateral slidings. Available on request, by adding (D) at the end of the code.

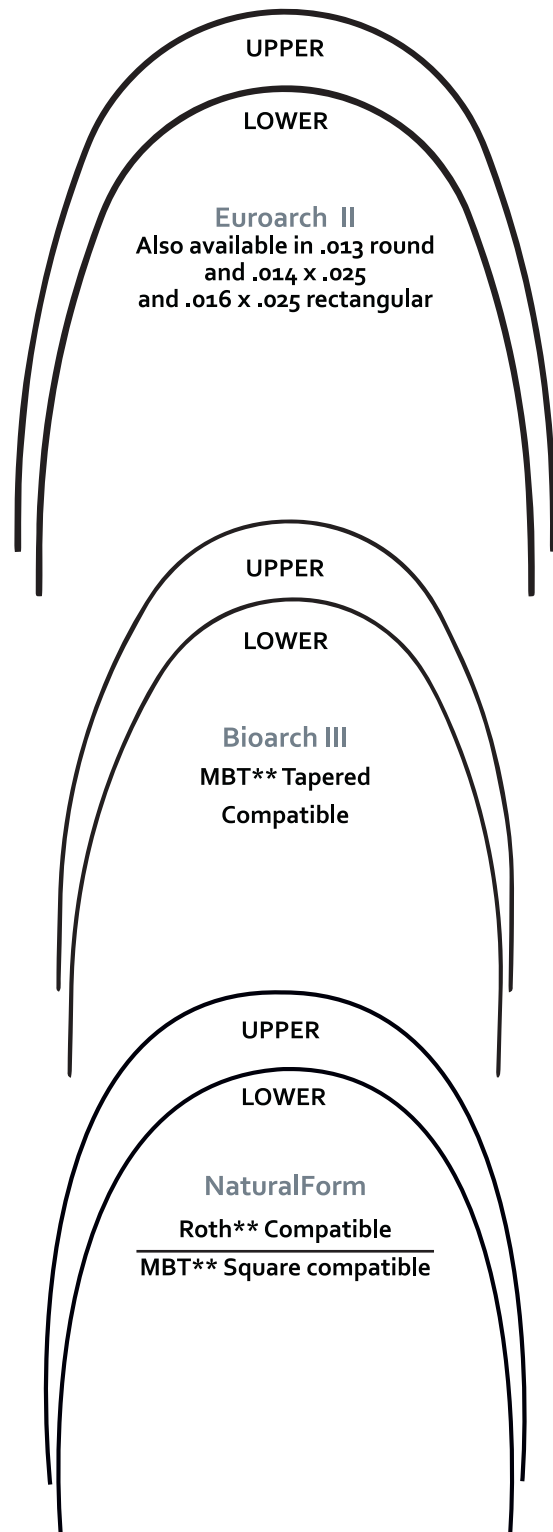
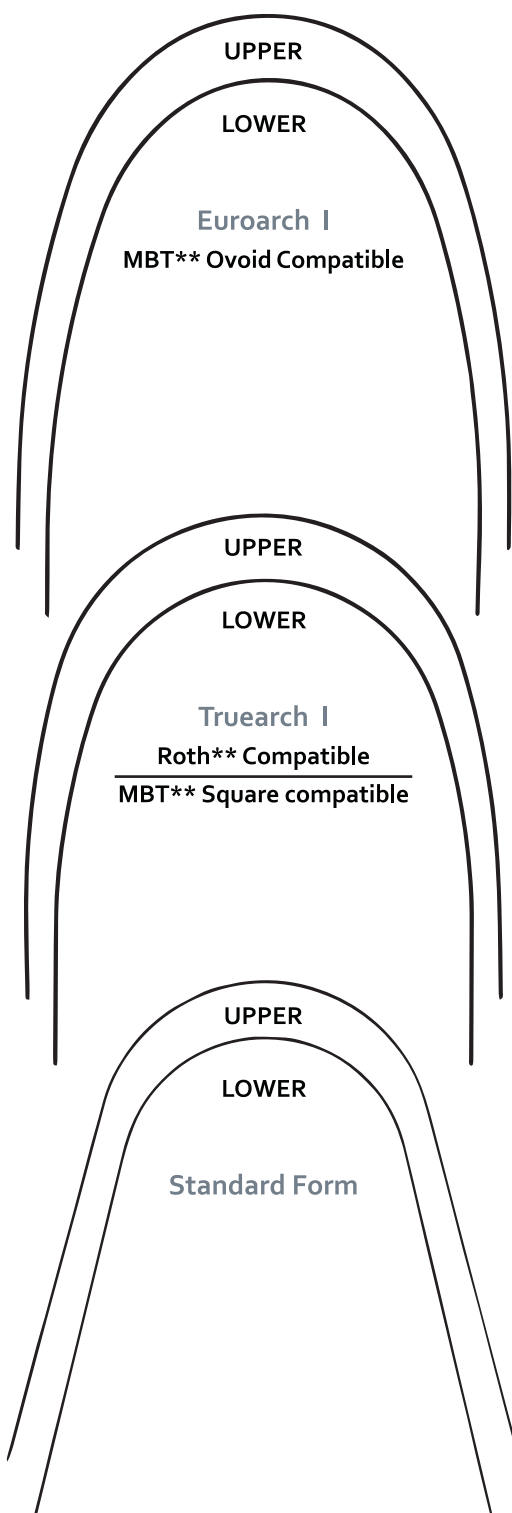

Tavole di comparazione / *Comparison tables*

Pollici / Millimetri >>> 1 inch = 25,4 mm / 1 mm = 0,0394 inch

Inch / Millimeters >>> 1 inch = 25,4 mm / 1 mm = 0,0394 inch

INCH	MM	INCH	MM	INCH	MM	INCH	MM
.001	0,03	.032	0,81	.063	1,60	.094	2,39
.002	0,05	.033	0,84	.064	1,63	.095	2,41
.003	0,08	.034	0,86	.065	1,65	.096	2,44
.004	0,10	.035	0,89	.066	1,68	.097	2,46
.005	0,13	.036	0,91	.067	1,70	.098	2,49
.006	0,15	.037	0,94	.068	1,73	.099	2,51
.007	0,18	.038	0,96	.069	1,75	.100	2,54
.008	0,20	.039	0,99	.070	1,78	.110	2,80
.009	0,23	.040	1,02	.071	1,80	.115	2,92
.010	0,25	.041	1,04	.072	1,83	.120	3,05
.011	0,28	.042	1,07	.073	1,85	.125	3,18
.012	0,30	.043	1,09	.074	1,88	.130	3,30
.013	0,33	.044	1,12	.075	1,90	.135	3,43
.014	0,36	.045	1,14	.076	1,93	.140	3,56
.015	0,38	.046	1,17	.077	1,96	.145	3,68
.016	0,41	.047	1,19	.078	1,98	.150	3,81
.017	0,43	.048	1,22	.079	2,01	.155	3,94
.018	0,46	.049	1,24	.080	2,03	.160	4,06
.019	0,48	.050	1,27	.081	2,06	.165	4,19
.020	0,51	.051	1,30	.082	2,08	.170	4,32
.021	0,53	.052	1,32	.083	2,11	.175	4,44
.022	0,56	.053	1,35	.084	2,13	.180	4,57
.023	0,58	.054	1,37	.085	2,16	.185	4,70
.024	0,61	.055	1,40	.086	2,18	.190	4,83
.025	0,64	.056	1,42	.087	2,21	.195	4,95
.026	0,66	.057	1,45	.088	2,23	.200	5,08
.027	0,69	.058	1,47	.089	2,26	.210	5,33
.028	0,71	.059	1,50	.090	2,29	.220	5,59
.029	0,74	.060	1,52	.091	2,31	.230	5,84
.030	0,76	.061	1,55	.092	2,34	.240	6,10
.031	0,79	.062	1,57	.093	2,36	.250	6,35

Unità di peso / *Unit of weight*

1 mg	= 0,0154 grani
1 g	= 0,0353 oz
1 kg	= 2,2046 lb
1 oz	= 28,35 g
1 lb	= 16 oz = 0,45 kg

Unità di forza / *Unit of force*

1 N/mm ²	= 14,223 psi
1 psi	= 0,070 N/mm ²

Sistema FDI / *FDI system*

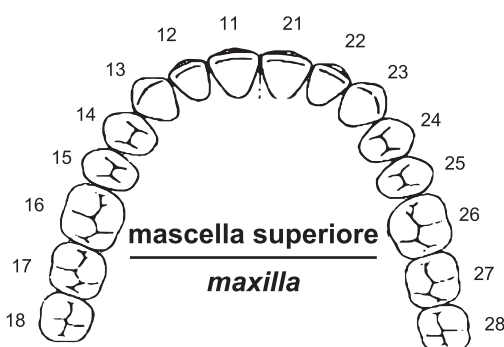

superiore a destra / <i>upper right</i>	superiore a sinistra / <i>upper left</i>
18 17 16 15 14 13 12 11	21 22 23 24 25 26 27 28
inferiore a destra / <i>lower right</i>	inferiore a sinistra / <i>lower left</i>
48 47 46 45 44 43 42 41	31 32 33 34 35 36 37 38

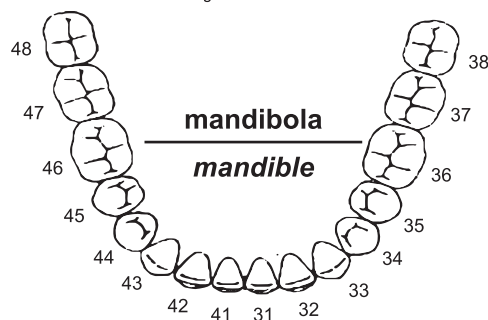

INCH		MM
1/64"	= 0,0156	0,04
1/32"	= 0,0312	0,79
1/16"	= 0,0625	1,59
1/8"	= 0,0125	3,18
1/4"	= 0,25	6,35
3/8"	= 0,375	9,52
1/2"	= 0,5	12,70
5/8"	= 0,625	15,88
3/4"	= 0,75	19,05
7/8"	= 0,875	22,22
1"	= 1,0	25,40

Indice alfabetico

> A

A.J. Wilcock® filo australiano
 Archetto e strisce per stripping
 Archi con post dritto
 Archi Cu-Ni-Ti
 Archi curva inversa Ni-Ti
 Archi e fili in acciaio
 Archi e fili in acciaio intrecciati
 Archi estetici
 Archi extraorali
 Archi in acciaio
 Archi in acciaio looped, posted
 Archi linguali universali
 Archi Ni-Ti
 Archi Ni-Ti Superelastici
 Archi Termici Ni-Ti (Eclipse)
 Archi Termici Ni-Ti (OrthoWorld)
 Attacchi Bright V-Slot
 Attacchi Eclipse
 Attacchi Eclipse smart active
 Attacchi Eclipse smart passive
 Attacchi in ceramica
 Attacchi in ceramica self-ligating
 Attacchi in resina
 Attacchi in zaffiro
 Attacchi Maximus

> B

Bande anatomiche TX
 Bande molari GX
 Bande molari TX
 Bande prepuntate TX
 Barre palatali
 Biotitan archi e fili
 Bite BumperTM
 Bite occlusali X-Space
 Bottone per estrusione con catena
 Bottoni in ceramica
 Bottoni linguali
 Braccetti saldati a laser X-Space
 Buste porta lavori

> C

Catenelle elastiche Eclipse
 Catenelle elastiche OrthoWorld
 Chiavetta snodata di sicurezza X-Space
 Contrangolo 4:1 - "Twist"
 Cucchiaini porta impronte per ortodonzia
 Cuffia con mentoniera
 Cuffia per trazioni di sicurezza
 Custodia di tessuto

B3
I4
B6
A4
A7
B2
B4
C2
H11
B3
B6
A8
A2
A5
A3
A6
D3
D2
D5
D6
C3
C4
C6
C5
D4

E7
E2
E7
E7
B8
B5
I3
K10
B9
B9
B9
K9
K16

H3
H3
K8
L8
I10
H10
H9
H10

> D

Dabliu apribocca
 Dabliu Stone tipo III ortodontico
 Dabliu Stone tipo IV extra duro ortodontico
 Dabliu Wax cera ortodontica
 Dinamometri
 Disco diamantato per stripping
 Dispenser per attacchi

I6
K13
K13
I9
H9
I4
I9

> E

Easy Form Aspy
 Easy Form Evolution
 Elastici extraorali
 Elastici intraorali - extraorali G&H
 Elastici intraorali Maximus
 Elastici latex free
 Extreme Foto G.I.
 Extreme Foto Ortho
 Extreme One-Step
 Extreme One-Step G.I.
 Extreme Ortho Glass L.C.

M3
M2
H8
H6
H7
H8
G2
G2
G5
G6
G6

> F

Fascia per trazioni cervicali
 Fili dritti e spolette Ni-Ti
 Fili e Tubi elastici
 Filo in matassa
 Filo per ganci X-Space
 Fogli in acetato per tracciati
 Fresa a punta per materiali termoplastici
 Frese per composito
 Fulcro di rotazione

H9
A7
H2
B10
K11
I9
I5
I5
H2

> G

Ganci a palla
 Ganci chirurgici da grippare

K11
B7

> K

Kit ortodontico prevenzione

I10

> L

Legature elastiche ECLIPSE
 Legature elastiche ORTHOWORLD
 Legature elastiche OVERTIE SELECT
 Legature elastiche precaricate
 Legature metalliche Kobayashi
 Legature metalliche preformate
 Legature preformate lunghe
 Lingual Sheath
 Lip bumpers

H4
H5
H4
H5
B10
B10
B10
E10
H10

> M

Maschera facciale	H11
Maschera facciale dinamica	H12
Micro Stop da grippare	B7
Micro viti X-Space	K7
Mini - Mold	I3
Molle in acciaio	B7
Molle Ni-Ti aperte	A9
Molle Ni-Ti aperte per distalizzare	A9
Molle Ni-Ti chiuse	A10

> N

Negativoscopio da tavolo LED	M4
------------------------------	----

> O

Occhielli in composito	B8
OrthAnchor	F2
Ortho Box & Ortho Bite	I11
Ortho Control	I2
Ortho Flow fotopolimerizzante	G3
Ortho Flow Plus fotopolimerizzante	G3
Ortho Form placche termoformabili	K14
Ortho Kit	F4
Ortholoy archi e fili blu	B5
Over Etch acido ortofosforico 35%	G4

> P

Pentola a pressione	M4
Pinze Perfect Line	L2
Pomice extra fine	K13
Porta pinze	I9
Portaprotesi	I12
Puntatrice HL-WDII	M4

> R

Resina ortodontica autopolimerizzante	K12
---------------------------------------	-----

> S

S&TCR	J2
Saldatura in argento	K12
Separatori elastici	H2
Spazzole a disco per materiali termoplastici	I5
Specchi per foto diagnostiche	I8
Strisce per splintaggio	I4

> T

Tubi da cementare	E9
Tubi da cementare convertibili	E6
Tubi da cementare non convertibili	E5

Tubi da puntare	E8
Tubi da puntare non convertibili	E3
Tubi da puntare non convertibili	E4
Tubi mini da cementare 1° & 2° molare	E5
Tubo per extraorale X-Space	K8

> U

Ultra Flux	K12
------------	-----

> V

Viti a ventaglio X-Space	K6
Viti ad arco per mandibola X-Space	K6
Viti monolaterali con guida a U X-Space	K4
Viti per bite-jumping X-Space	K8
Viti per espansione X-Space	K2
Viti tridirezionali X-Space	K5

> Z

Zoccolatori per modelli	I9
-------------------------	----

Alphabetical index

>

1° & 2° molar bondable mini tubes
35% phosphoric acid
4:1 contrangle - "Twist"

E5
G4
L8

Extreme One-Step G5
Extreme One-Step G.I. G6
Extreme Ortho Glass L.C. G6
Extrusion button with chain B9

> A

A.J. Wilcock® australian wire
Acetate tracing sheets

B3
I9

> F

Face masks H11
Facebows H11
Fan-type screws K6

> B

Ball hooks K11
Biotitan archwires and wires B5
Bite Bumper™ I3
Bite-jumping screws K8
Blue Orthloy wires and archwires B5
Bondable tubes E9
Brackes dispensers I9

> G

GX molar bands E2

> C

Ceramic brackets C3
Ceramic buttons B9
Cervical neckpads H9
Cheek retractors I6
Chin cup headcup H10
Clasp wire K11
Composite eyelets B8
Convertible bondable tubes E6
Convertible weldable tubes E4
Crimpable Micro Stops B7
Cu-Ni-Ti archwires A4

> H

High pull headcaps H9

> I

Interproximaldiamond discs I4
Intraoral & Extraoral elastics G&H H6
Intraoral elastics MAXIMUS H7

> K

Kobayashi ligature ties B10

> D

Disc brushes for thermoplastic material I5
Disposable impression trays I10
Distalizing open coil springs A9
Dynamic face mask H12

> L

Laser welded arms K9
Latex free elastics H8
LED table-top negatvoscope M4
Ligature ties Eclipse H4
Ligature ties OrthoWorld H5
Light-curing Ortho Flow G3
Light-curing Ortho Flow Plus G3
Lingual buttons B9
Lingual sheaths E10
Lip bumpers H10
Long pre-cut ligature wires B10

> E

Easy Form Aspy M3
Easy Form Evolution M2
Eclipse brackets D2
Eclipse smart active brackets D5
Eclipse smart passive brackets D6
Elastomeric chains Eclipse H3
Elastomeric chains OrthoWorld H3
Elastomeric chains OverTie Select H4
Elastomeric separators H2
Elastomeric wires and tubes H2
Expansion screws K2
Extra fine pumice K13
Extraoral elastics H8
Extraoral tube K8
Extreme Foto G.I. G2
Extreme Foto Ortho G2

> M

Mandibular bow screws K6
Maximus brackets D4
Micro screws K7
Mini - Mold I3
Multi strand stainless steel archwires B4

> N

Ni-Ti archwires A2
Ni-Ti closed coil springs A10
Ni-Ti open coil springs A9
Ni-Ti spools and straight wires A7
Non-convertible bondable tubes E5
Non-convertible weldable tubes E3

> O

Occlusal bites	K10
OrthAnchor	F2
Ortho Box & Ortho Bite	I11
Ortho Control	I2
Ortho Kit	F4
Orthodontic wax	I9

> P

Photographic mirrors	I8
Phropylaxis orthodontic kit	I10
Plastic model bases	I9
Plier holder	I9
Pliers and instruments	L2
Pointed burs for thermoplastic material	I5
Pre-cut ligature wires	B10
Pre-loaded ligature ties	H5
Pressure pot	M4
Prothesis cases	I12

> R

Removal and finishing burs	I5
Resin brackets	C6
Reverse curve Ni-Ti archwires	A7
Rotating wedge	H2

> S

S&TCR	J2
Safety release modules	H9
Sapphire brackets	C5
Self-curing orthodontic resin	K12
Self-ligating ceramic brackets	C4
Silver solder	K12
Splinting strips	I4
Spooled bulk ligature wire	B10
Stainless steel archwires	B3
Stainless steel archwires and wires	B2
Stainless steel looped and posted archwires	B6
Stainless steel springs	B7
Storage case	H10
Straight post archwires	B6
Stripping instrument and lightning strips	I4
Superelastic Ni-Ti archwires	A5
Surgical hooks	B7
Swivel Safety Key	K8

> T

Thermal Ni-Ti archwires (Eclipse)	A3
Thermal Ni-Ti archwires (OrthoWorld)	A6
Thermoforming plates	K14
Tridirectional screws	K5
TX prewelded bands	E7
TX anatomical bands	E7
TX molar bands	E7
Type III orthodontic gypsum	K13

Type IV extra hard orthodontic gypsum **K13**

> U

Ultra Flux	K12
Ultraesthetic archwires	C2
Universal lingual archwires	A8
U-shaped guide monolateral screws	K4

> V

V-slot brackets	D3
-----------------	----

> W

Weldable tubes	E8
Welding machine HL-WDII	M4

> Z

Ziplock plastic bags	K16
----------------------	-----



Dental World s.r.l. - Via Antichi Pastifici, 15 - 70056 Molfetta (BA) ITALY
tel. +39 080.338.10.04 / fax +39 080.338.66.17
www.dental-world.it / info@dental-world.it

