

**MONOUSO  
VARIE**

**DISPOSABLE  
VARIOUS**

**PROFILASSI  
ATTREZZATURA**

**PROPHYLAXIS  
EQUIPMENT**



OFFICIAL CATALOGUE

# INDICE Index

## ➤ PROFILASSI | PROPHYLAXIS

- Brilliance pag. 3
- Brilliance Plus pag. 4
- Brilliance Plus Dual pag. 5
- Clean Paste pag. 6
- Clean Flow pag. 7

## ➤ MONOUSO | DISPOSABLE

- Rotoli sterilizzanti pag. 8
- Buste sterilizzanti pag. 8
- Protect Paper pag. 9
- Protect Towels pag. 9
- Protect Bibs pag. 10
- Protect Masks pag. 11
- Pro Ice pag. 12
- Protect Chair pag. 13
- Protect Head pag. 13
- Pro Tray pag. 14
- Pro Glass pag. 14
- Protect Plus pag. 15
- Aghi applicatori pag. 15
- Acus Jet pag. 16
- Eazy Tray pag. 17
- Protect Rolls pag. 17
- Protect Aspire pag. 18
- Protect Carpet pag. 18
- Dabliu Protector pag. 19
- Guaine per manipoli - Bio pag. 20
- Guaine per tubi d'aspirazione - Bio pag. 20
- Guaine per siringhe - Bio pag. 20
- Guaine per lampade a penna - Bio pag. 21
- Guaine per videocamera - Bio pag. 21
- Guaine per lampade alogene - Bio pag. 21
- Guaine per sensori - Bio pag. 22
- Guaine per specchietti e sensori - Bio pag. 22
- Guaine per radiografico - Bio pag. 22
- Guaine per impugnature a "T" - Bio pag. 23
- Guaine Bite Block- Bio pag. 23
- Tasche protettive per RX - Bio pag. 23
- Dabliu Brush pag. 24
- Dabliu Ultra Brush pag. 24
- Dabliu Endo Brush pag. 24
- Pennellini monouso pag. 25
- Applicatori con manico pag. 25



## **VARIE | VARIOUS**

- Ortho Box pag. **26**
- Ortho Bite pag. **27**
- Portaprotesi pag. **28**
- Zoccolatori pag. **29**
- Dispenser per rulli pag. **29**
- Visiera Galaxy e Galaxy DPI pag. **30**
- Visiera Vision e Vision DPI pag. **31**
- Protective Glass pag. **32**
- Dabliu Bite Opener pag. **32**
- Tazzine per resina pag. **33**
- Anelli codificatori pag. **33**
- Encoder Tape pag. **34**
- Cristal Tooth pag. **34**
- Dabliu Apribocca pag. **35**
- RX & RVG Positioner pag. **36**
- Lubri Spray pag. **37**



## **ATTREZZATURA | EQUIPMENT**

- EasyForm Evolution pag. **38**
- EasyForm Aspy pag. **39**
- Ortho Form pag. **40**
- Fisio Surgery pag. **42**
- Fisio Surgery Touch pag. **43**

# BRILLIANCE

Sbiancante cosmetico monocomponente con 16% di perossido di carbamide

16% carbamide peroxide monocomponent whitening cosmetic system



0000015 Brilliance 16%

## APPLICATIONS

- Trattamento sbiancante di cosmesi domiciliare a base di perossido di carbamide potenziato al 16%, monocomponente, incolore  
*Home cosmetic whitening system with 16% enhanced carbamide peroxide, monocomponent, colorless*
- Indicato per i trattamenti di mantenimento, dopo quello professionale  
*Recommended for maintenance treatments, after professional treatment*

## CHARACTERISTICS

- Molecola: perossido di carbamide  
*Molecule: carbamide peroxide*
- Tipologia: gel monocomponente  
*Typology: monocomponent gel*
- Colore: trasparente  
*Colour: transparent*
- Attivazione aerea  
*Air activation*
- Desensibilizzante e mineralizzante  
*Desensitizing and mineralizing*
- Nessun cambiamento di colore  
*No colour change*
- Gusto menta  
*Mint flavour*

## ADVANTAGES

- Sbiancamento in un'unica seduta  
*Whitening in a single session*
- Assenza di sensibilità dentinale  
*No dentinal sensitivity*
- Ricco di nitrato di potassio  
*Rich in potassium nitrate*
- Rimuove macchie di caffeina e nicotina  
*It removes caffeine and nicotine stains*

## PACKAGING

- 3 ml x 5 syringes gel
- 1 ortho bite
- 2 placche termoformabili morbide da 1mm in materiale EVA (ETILENE VINIL ACETATO)  
*2 thermoforming sheets in EVA Soft material, 1mm*
- Tips

# BRILLIANCE PLUS

Sbiancante cosmetico monocomponente con 6% di perossido di idrogeno

6% hydrogen peroxide monocomponent whitening cosmetic system



00000016 Brilliance Plus 6%

## APPLICATIONS

- Trattamento sbiancante cosmetico a base di perossido di idrogeno potenziato al 6%, monocomponente  
*Cosmetic whitening treatment based on 6% enhanced hydrogen peroxide, mono-component*
- Indicato per lo sbiancamento professionale di denti vitali e monconi devitalizzati, monocomponente, pratico ed efficace  
*Recommended for the professional bleaching of vital teeth and devitalized cores, monocomponent, practical and efficient*

## CHARACTERISTICS

- Molecola: perossido d'idrogeno al 6%  
*Molecule: 6% hydrogen peroxide*
- Tipologia: monocomponente  
*Typology: mono-component*
- Attivazione chimica, con laser o luce LED  
*Chemical, laser or LED light activation*
- Desensibilizzante e mineralizzante  
*Desensitizing and mineralizing*

## ADVANTAGES

- Sbiancamento in un'unica seduta  
*Whitening in a single session*
- Assenza di sensibilità dentinale  
*No dentinal sensitivity*
- Ricco di nitrato di potassio  
*Rich in potassium nitrate*

## PACKAGING

- 3 ml x 2 gel syringes each
- 3,5 g x 1 syringe dam
- Tips

# BRILLIANCE PLUS DUAL

Sbiancante cosmetico bicomponente con 6% di perossido di idrogeno

6% hydrogen peroxide bicomponent whitening cosmetic system



00000018 Brilliance Plus Dual 6%

## APPLICATIONS

- Trattamento sbiancante cosmetico a base di perossido di idrogeno potenziato al 6%, bicomponente  
*Professional whitening treatment based on 6% enhanced hydrogen peroxide, bi-component*
- Indicato per lo sbiancamento di denti vitali e monconi devitalizzati, bicomponente da attivare al momento, per una maggiore efficacia  
*Recommended for the bleaching of vital teeth and devitalized cores, bi-component to be activated upon use, for enhanced effectiveness*

## CHARACTERISTICS

- Molecola: perossido d'idrogeno al 6%  
*Molecule: hydrogen peroxide*
- Tipologia: bicomponente (da miscelare)  
*Typology: Bi-component (to be mixed)*
- Colorazione rossa  
*Red color*
- Attivazione chimica, con laser o luce LED  
*Chemical, laser or LED light activation*
- Formula PF (nitrato di potassio e fluoruro)  
*PF formula (potassium nitrate and fluoride)*

## ADVANTAGES

- Sbiancamento in un'unica seduta  
*Whitening in a single session*
- Assenza di sensibilità dentinale  
*No dentinal sensitivity*
- Ricco di nitrato di potassio  
*Rich in potassium nitrate*

## PACKAGING

- 1,5 ml x 2 syringes gel
- 7,5 ml x 2 desensitizer syringes
- 3,5 g x 1 syringe dam
- 2 Collettori / 2 Manifolds
- Tips

# CLEAN PASTE

Pasta per profilassi

*Prophylaxis paste*



## DESCRIPTION

Pasta per profilassi pronta all'uso indicata per la pulizia e la lucidatura dei denti

*Ready to use prophylaxis paste, recommended for cleaning and polishing theet*

## CHARACTERISTICS

- Antischizzo  
*Non-splatter formula*
- Facile da risciacquare  
*Easy to rinse*

## SIZE

- Grana Grossa  
*Coarse grain*
- Grana Media  
*Medium grain*

## FLAVOURS

- Ciliegia / *Cherry*
- Menta / *Mint*
- Piña Colada / *Piña Colada*
- Bubble gum / *Bubble gum*
- Arancia / *Orange*
- Lampone / *Raspberry*
- Senza fluoro - Gusto neutro / *Fluoride-free - Neutral flavour*

## Clean Paste - Medium Grain:

9100814	Clean Paste - Medium - Cherry
9100815	Clean Paste - Medium - Mint
9100816	Clean Paste - Medium - PC
9100817	Clean Paste - Medium - BG
9100818	Clean Paste - Medium - Orange
9100819	Clean Paste - Medium - Raspberry
9100820	Clean Paste - Medium - Neutral

## Clean Paste - Coarse Grain:

9100821	Clean Paste - Coarse - Cherry
9100822	Clean Paste - Coarse - Mint
9100823	Clean Paste - Coarse - PC
9100824	Clean Paste - Coarse - BG
9100825	Clean Paste - Coarse - Orange
9100826	Clean Paste - Coarse - Raspberry
9100827	Clean Paste - Coarse - Neutral

## PACKAGING

100 g jar

# CLEAN FLOW

Polvere per profilassi a base di bicarbonato di sodio

*Sodium bicarbonate prophylaxis powder*



## Clean Flow - Perio Twenty:

0003930	Clean Flow - Perio Twenty - Lemon
0003933	Clean Flow - Perio Twenty - Mint
0003939	Clean Flow - Perio Twenty - Cherry
0003936	Clean Flow - Perio Twenty - Neutral

## Clean Flow - Soft Forty:

0003931	Clean Flow - Soft Forty - Lemon
0003934	Clean Flow - Soft Forty - Mint
0003940	Clean Flow - Soft Forty - Cherry
0003937	Clean Flow - Soft Forty - Neutral

## Clean Flow - Standard Sixty:

0003932	Clean Flow - Standard Sixty - Lemon
0003935	Clean Flow - Standard Sixty - Mint
0003941	Clean Flow - Standard Sixty - Cherry
0003938	Clean Flow - Standard Sixty - Neutral

## DESCRIPTION

Polvere per profilassi a base di bicarbonato di sodio con particelle ottimizzate, indicata per denti sensibili

*Sodium bicarbonate prophylaxis powder with optimized particles, indicated for sensitive teeth*

## FLAVORS

- Limone / Lemon
- Menta / Mint
- Ciliegia / Cherry
- Neutro / Neutral

## GRANULOMETRY

- Perio Twenty (20 µm)
- Soft Forty (40 µm)
- Standard Sixty (60 µm)

## PACKAGING

- 300 g bottle

## CHARACTERISTICS

### • Perio Twenty

La granulometria Perio Twenty ha delle particelle che garantiscono un minimo impatto sulle gengive, tessuti molli e denti naturali anche con trattamenti frequenti

*Perio Twenty granulometry has particles that guarantee a minimal impact on gums, soft tissues, and natural teeth even with recurring treatments*

### • Soft Forty

La granulometria Soft Forty ha delle particelle che garantiscono il massimo confort in tutti i tipi di profilassi. Ideale nella prevenzione

*Soft Forty granulometry has particles that guarantee the maximum comfort in every kind of prophylaxis. Ideal during the prevention*

### • Standard Sixty

La granulometria Standard Sixty ha delle particelle ideali nei bambini e pazienti affetti da sensibilità dentinale, agisce preservando i tessuti molli e lo smalto

*Standard Sixty granulometry has particles ideal for kids and patients suffering of dental sensitivity, operates preserving soft tissues and enamel*



# ROTOLI STERILIZZANTI

## Rotoli per sterilizzazione

### Sterilization rolls



#### Box

00520044	Sterilization Reels - 55 x 200 mt	12 pcs
00520045	Sterilization Reels - 75 x 200 mt	8 pcs
00520046	Sterilization Reels - 100 x 200 mt	6 pcs
00520047	Sterilization Reels - 200 x 200 mt	4 pcs
00520050	Sterilization Reels - 150 x 200 mt	4 pcs
00520051	Sterilization Reels - 250 x 200 mt	2 pcs
00520052	Sterilization Reels - 300 x 200 mt	2 pcs
00520053	Sterilization Reels - 350 x 200 mt	1 pc
00520054	Sterilization Reels - 400 x 200 mt	2 pcs

#### DESCRIPTION

I nostri rotoli per sterilizzazione sono realizzati in plastica ad uso medico denominata film laminato trasparente. Quest'ultimo deriva da poliestere e polipropilene sottoposti a "trattamento corona" e da carta certificata e studiata per assicurare un'elevata protezione antibatterica per la sterilizzazione medica STEAM, EO e FORM. Gli inchiostri utilizzati sono certificati ISO 11140, a base d'acqua e atossici con un leggero cambiamento di colore.

*Our sterilization reels are made by a plastic medical use material called laminated transparent film; it comes from "corona treatment" polyester and polypropylene and from certified and studied best paper to assure an high antibacterial protection for STEAM,EO and FORM medical sterilization. The inks we use are ISO 11140 certified, water based and no-toxic, with a minimal change in color.*

#### PACKAGING

- 200 m x 1 pc

# BUSTE STERILIZZANTI

## Rotoli autosigillanti

### Autosealing pouches



#### Box

00400001	Autosealing pouches - 90x250	15 pcs
00400002	Autosealing pouches - 140x260	6 pcs
00400011	Autosealing pouches - 300x450	1 pc

#### DESCRIPTION

Carta "medical grade" ad alta grammatura con 3 laterali sigillanti con nastro biadesivo. La stampa viene eseguita all'esterno dello spazio utilizzato per la sterilizzazione, sulle saldature tra la carta e il film.

*Medical-grade paper with high grammage and 3 laterals sealing with bioadhesive tape. Printing is made outside the space used for sterilization, on the weldings between paper and film.*

#### PACKAGING

- 200 pouches x 1 bag

# PROTECT PAPER

Tovagliette in carta crespa

*Crinkled paper towels*



## DESCRIPTION

Protect paper sono tovagliette in carta crespa, ideali per coprire vassoi in alluminio e supportare il ciclo in autoclave. Vassoio in cartoncino fornito in dotazione.

*Protect paper are crinkled paper towels recommended to cover aluminum trays and to withstand autoclave sterilization cycles. Cardboard tray supplied.*

## PACKAGING

- 18x28 cm - 250 pcs.

## Available colours



\*Disponibili su richiesta/Available on request

00700101	Protect paper - White
00700102	Protect paper - Light blue
00700103	Protect paper - Green
00700104	Protect paper - Orange*
00700105	Protect paper - Yellow*
00700106	Protect paper - Pink*
00700107	Protect paper - Lilac*

# PROTECT TOWELS

Salviette assorbenti plastificate

*Paper/plastic coated absorbent towels*



## DESCRIPTION

Protect Towels sono salviette monouso, piegate, plastificate, assorbenti e impermeabili composte da un velo di pura ovatta di cellulosa ed un velo di polietilene.

*Protect Towels are disposable, folded and plastic coated towels; they are waterproof and made up of a layer of pure cellulose and a layer of polyethylene.*

## PACKAGING

- 33x45 cm - 500 pcs

## Available colours



\*Disponibili su richiesta/Available on request

00700041	Protect Towels - White*
00700042	Protect Towels - Light blue
00700043	Protect Towels - Green
00700044	Protect Towels - Orange
00700045	Protect Towels - Yellow
00700046	Protect Towels - Pink*
00700047	Protect Towels - Lilac
00700048	Protect Towels - Blue med.
00700049	Protect Towels - Peach*
00700050	Protect Towels - Bordeaux*
00700051	Protect Towels - Black*

# PROTECT BIBS

Mantelline in rotolo carta plastica

Paper/plastic roll bibs



\*Disponibili su richiesta/Available on request

**50x60 - 80 tears**

00700061	Protect Bibs - White*
00700062	Protect Bibs - Light blue
00700063	Protect Bibs - Green
00700064	Protect Bibs - Orange
00700065	Protect Bibs - Yellow
00700066	Protect Bibs - Pink*
00700067	Protect Bibs - Lilac
00700068	Protect Bibs - Blue med.
00700069	Protect Bibs - Peach*
00700070	Protect Bibs - Bordeaux*

## DESCRIPTION

Protect Bibs sono mantelline protettive in rotolo composte da un velo di pura ovatta di cellulosa ed uno di polietilene, dotate di area di pretaglio per agevolare la vestibilità

*Protect Bibs are protective bibs in rolls made with a layer of pure cellulose and one of polyethylene, equipped with a pre-cutting area to facilitate wearability*

## SIZES

- 50x60 cm - 80 strappi/*tears*

## PACKAGING

- Confezione: 1 rotolo  
*Packaging: 1 roll*
- Box: 6 rotoli  
*Box: 6 rolls*

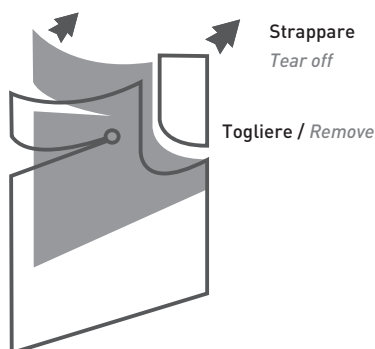
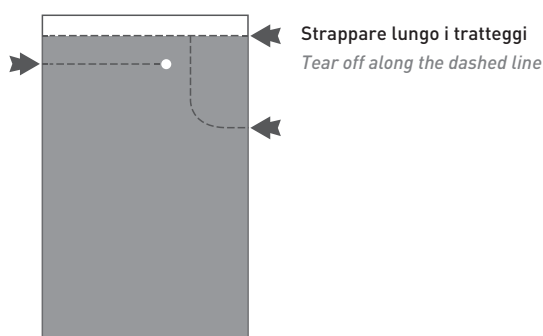

# PROTECT MASKS

## Mascherine chirurgiche tipo IIR

### IIR surgical face masks



\*Disponibili su richiesta/Available on request

#### Adult: 9x17,5 cm

00700071	Protect Masks - Lime
00700072	Protect Masks - Light blue
00700073	Protect Masks - Green
00700074	Protect Masks - Orange*
00700075	Protect Masks - Yellow*
00700076	Protect Masks - Pink
00700077	Protect Masks - Lilac
00700078	Protect Masks - Blue med.
00700079	Protect Masks - White
00700080	Protect Masks - Black
00700085	Protect Masks - Jeans

#### Junior: 9x14,5 cm

00700071-JR	Protect Masks Junior - Lime
00700072-JR	Protect Masks Junior - Light blue
00700073-JR	Protect Masks Junior - Green
00700074-JR	Protect Masks Junior - Orange*
00700075-JR	Protect Masks Junior - Yellow*
00700076-JR	Protect Masks Junior -Pink
00700077-JR	Protect Masks Junior - Lilac
00700078-JR	Protect Masks Junior - Blue med.
00700079-JR	Protect Masks Junior - White
00700080-JR	Protect Masks Junior - Black

### DESCRIPTION

Protect Masks, mascherine chirurgiche monouso ad **alta efficienza filtrante**, leggere e confortevoli sulla pelle. Protect Masks sono dotate di elastici e composte da **3 strati** in polipropilene con **strato intermedio filtrante**. Barretta nasale incorporata. Prive di lattice. Conformi allo standard CE.

Protect Masks sono disponibili nella versione **ADULT** (dim. 9 x 17,5 cm) e **JUNIOR** (dim. 9 x 14,5 cm).

*Protect Masks, disposable surgical masks with **high filtration efficiency**, light and comfortable on the skin. Protect Masks have elastic straps and are composed of **3 layers** of polypropylene with a **filter layer in between**. Built-in nose bar. Latex-free. Compliant with CE standard. Protect Masks are available in **ADULT** (size 9 x 17.5 cm) and **JUNIOR** (size 9 x 14.5 cm) versions.*

### SIZES

- ADULT: 9x17,5 cm
- JUNIOR: 9x14,5 cm

### PACKAGING

- Busta: 10 mascherine  
*Bag: 10 masks*
- Box: 5 buste  
*Box: 5 bags*



\*Available also for kids

# PRO ICE

Ghiaccio istantaneo monouso in TNT e PE

*Disposable instant ice in nonwoven fabric and polyethylene*



POLYETHYLENE



NON-WOVEN FABRIC

00700030A/24	PRO Ice - TNT
00700033A/24	PRO Ice - PE

## DESCRIPTION

Progettato e realizzato in Italia per fornire un rapido ed efficace sollievo dal dolore, PRO Ice è la soluzione ideale per una vasta gamma di condizioni fisiche come distorsioni, traumi, ematomi, dolori e gonfiori. È impiegabile in più settori: medicale, dentale e sportivo.

*Designed and made in Italy to provide fast and effective pain relief, PRO Ice is the ideal solution for a wide range of physical conditions such as distorsions, traumas, hematomas, pain and swellings. It can be used in several sectors: medical, dental and sports.*

## CHARACTERISTICS

- Costituito da una miscela di sali azotati e acqua  
*Made up by a mixture of nitrogen salts and water*
- Temperatura di raffreddamento fino a  $\pm 2^{\circ}\text{C}$   
*Cooling temperature up to  $\pm 2^{\circ}\text{C}$*
- Durata fino a  $\pm 30$  min  
*Duration up to  $\pm 30$  min*
- Facile da utilizzare: premendo al centro così da rompere la bolla interna ed attivare la reazione termica.  
*Easy to use: press towards the center in order to break the inner bubble and activate the thermic reaction.*

## ADVANTAGES

- Rapido sollievo.  
*Quick relief.*
- Disponibile in sacchetti in TNT, progettati appositamente per soddisfare le esigenze di coloro che hanno una pelle sensibile.  
*Available in TNT bags, specifically designed to meet the needs of those with sensitive skin.*
- Disponibile in sacchetti in PE progettati per offrire resistenza agli agenti chimici e fisici.  
*Available in PE bags designed to offer resistance to chemical and physical agents.*

## PACKAGING

- Cartone da 24 sacchetti  
*Box with 24 bags*
- Pedana da 98 cartoni  
*Pallet of 98 boxes*

**Brand e confezionamento personalizzabili su richiesta.**  
*Branding and packaging customizable on demand.*

# PROTECT CHAIR

Copriunito in TNT

*TNT chair cover*



## Available colours

- 1  2   
3  4  5

00700111	Protect Chair in TNT - White
00700112	Protect Chair in TNT - Light Blue
00700113	Protect Chair in TNT - Green
00700114	Protect Chair in TNT - Orange
00700118	Protect Chair in TNT - Blue med.

## DESCRIPTION

Protect chair è un copriunito monouso universale realizzato in TNT, anallergico e traspirante. Si compone di una copertura per la seduta ed una per lo schienale, dotate di elastico

*Protect chair is a disposable and universal chair cover in TNT material, non allergenic and transpiring. The chair cover set is composed of one seat cover and one back cover with elastic*

## PACKAGING

25 + 25 pcs

# PROTECT HEAD

Copritestiera in TNT

*TNT headrest cover*



## Available colours

- 1  2   
3  4  5

00700121	Protect Head in TNT - White
00700122	Protect Head in TNT - Light Blue
00700123	Protect Head in TNT - Green
00700124	Protect Head in TNT - Orange
00700128	Protect Head in TNT - Blue med.

## DESCRIPTION

Protect head è un copritestiera monouso, universale, realizzato in TNT, idrorepellente e traspirante, dotato di elastico

*Protect head is a disposable, waterproof and breathable headrest cover in TNT material, equipped with elastic bands*

## PACKAGING

100 pcs

# PRO TRAY

Vassoi monouso lisci e zigrinati

*Smooth and milled disposable dental tray*



## Available colours

1  2  3  4

### Pro Tray - Milled surface

00700191Z	Pro Tray - Milled - White
00700192Z	Pro Tray - Milled - Light Blue*
00700193Z	Pro Tray - Milled - Green*
00700194Z	Pro Tray - Milled - Orange*

### Pro Tray - Smooth surface

00700191L	Pro Tray - Smooth - White
00700192L	Pro Tray - Smooth - Light Blue*
00700193L	Pro Tray - Smooth - Green*
00700194L	Pro Tray - Smooth - Orange*

\*Disponibili su richiesta/Available on request

## DESCRIPTION

Pro Tray sono vassoi monouso in polistirene con bordo rinforzato, non sterili, resistenti a liquidi, cementi, acidi, disinfettanti a freddo per uso dentale. Disponibili nella versione liscia o zigrinata

*Pro Tray are disposable dental trays; made with polystyrene, they have a reinforced edge. Non-sterile, resistant to liquids, cements, acids, cold disinfectants for dental use. Available in the smooth or milled version*

## PACKAGING

400 pcs

# PRO GLASS

Bicchieri monouso

*Disposable cups*



## Available colours

1  2  3  4   
5  6  7  8  9

00700131	Protect Glass - White
00700132	Protect Glass - Light blue
00700133	Protect Glass - Green
00700134	Protect Glass - Orange
00700135	Protect Glass - Yellow*
00700136	Protect Glass - Pink*
00700137	Protect Glass - Lilac*
00700138	Protect Glass - Blue med.*
00700140	Protect Glass - Bordeaux*

\*Disponibili su richiesta/Available on request

## DESCRIPTION

Pro Glass sono bicchieri in plastica atossica, monouso, con bordino arrotondato e superficie esterna antiscivolo

*Pro Glass are disposable, not-toxic plastic cups, with curved edges and anti-slip outer surface*

## PACKAGING

- Confezione / Packaging: 100 pcs
- Box: 10 x 100 pcs

# PROTECT PLUS

Mantelline pretagliate con dispenser

*Pre-cutted bibs with dispenser*



00870001 Protect Plus

## DESCRIPTION

Protect Plus sono mantelline realizzate con 2 veli di pura ovatta di cellulosa ed uno di polietilene. Dotate di pretaglio, presentano una pratica tasca di raccolta liquidi e rifiuti e sono confezionate in un pratico dispenser in cartone

*Protect Plus are made of 2 layers of pure cellulose and one of polyethylene. They are pre-cutted, provided with a practical liquid and waste collection pocket and packaged in a practical cardboard dispenser*

## PACKAGING

68x48 cm - 100 pcs

# AGHI APPLICATORI

*Application needles*



00340111A	N°1 - Disposable tips - Blue - 100 pcs
00340112A	N°2 - Disposable tips - Black - 20G - 100 pcs
00340112B	N°3 - Disposable tips - Black - 22G - 100 pcs
00340158	N°4 - Disposable tips - Violet - 100 pcs
00340219-20	N°5 - Disposable tips - Curved - 20 pcs
00340219-50	N°5 - Disposable tips - Curved - 50 pcs
00340119-20	N°6 - Disposable tips - Straight - 20 pcs
00340119-50	N°6 - Disposable tips - Straight - 50 pcs

## DESCRIPTION

Aghi applicatori monouso per vari tipi di siringhe con attacco universale luer-lock

*Disposable applicator needles recommended for different kind of syringes with universal luer-lock connection*

## PACKAGING

N°1 - Blu / Blue: 100 pcs

N°2 - Neri / Black - 20G: 100 pcs

N°3 - Neri / Black - 22G: 100 pcs

N°4 - Viola / Violet: 100 pcs

N°5 - Curvi / Curved: 20/50 pcs

N°6 - Dritti / Straight: 20/50 pcs



# ACUS JET

**Aghi dentali per anestesia**

*Dental needles for anesthesia*

0,4x8 mm



Extra corto - intraligamentare  
*Extra short - intraligamentary*



**00200006** AcusJet 27G - 0,4x8mm

0,3x12 mm



Corto - intraligamentare  
*Short - intraligamentary*



**00200002** AcusJet 30G - 0,3x12mm

0,3x16 mm



Corto - intraligamentare  
*Short - intraligamentary*



**00200003** AcusJet 30G - 0,3x16mm

0,3x21 mm



Lungo - infiltrazione  
*Long - infiltration*



**00200004** AcusJet 30G - 0,3x21mm

0,3x25 mm  
0,4x25 mm

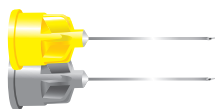

Lungo - infiltrazione  
*Long - infiltration*



**00200005** AcusJet 30G - 0,3x25mm

**00200010** AcusJet 27G - 0,4x25mm

0,4x38 mm



Lungo - mandibolare  
*Long - mandibular*



**00200012** AcusJet 27G - 0,4x38mm

## DESCRIPTION

Acus Jet sono aghi dentali monouso per anestesia. Presentano un cono filettato in polipropilene ed una cannula in acciaio inossidabile a parete ultrasottile con punta a triplice affilatura siliconata. Gli aghi sono sterilizzati con ossido di etilene, sigillati singolarmente e presentano lotto di produzione ed un indicatore di orientamento della punta

*Acus Jet are disposable dental needles for anesthesia. They present a polypropylene hub threading and an ultra-thin stainless steel cannula with a triple silicon-sharpened tip. These needles are sterilized with ethylene oxide, individually sealed and have a production lot and a tip orientation indicator*

## PACKAGING

- Confezione / *Packaging*: 100 pcs
- Box: 12 confezioni/ *packages*

## ON DEMAND

Le seguenti misure sono disponibili esclusivamente su richiesta:  
*The following sizes are available on demand only:*

<b>00200001</b>	AcusJet 30G - 0,3x8mm
<b>00200007</b>	AcusJet 27G - 0,4x12mm
<b>00200008</b>	AcusJet 27G - 0,4x16mm
<b>00200009</b>	AcusJet 27G - 0,4x21mm
<b>00200011</b>	AcusJet 27G - 0,4x36mm
<b>00200013</b>	AcusJet 25G - 0,5x8mm
<b>00200014</b>	AcusJet 25G - 0,5x38mm

# EAZY TRAY

Applicatori monouso per profilassi

*Disposable applicators for prophylaxis*



<b>00340146</b>	Eazy Tray - Small - Aqua Green
<b>00340147</b>	Eazy Tray - Medium - Yellow
<b>00340148</b>	Eazy Tray - Large - Blue

## DESCRIPTION

Eazy Tray sono applicatori doppi monouso per applicazioni topiche di gel al fluoro e jonofresi

*Eazy Tray are disposable double applicators, recommended for fluoride gel application and ionophoresis*

## PACKAGING

200 pcs (100 upper - 100 lower)

## SIZES

- Small - Aqua green
- Medium - Yellow
- Large - Blue

# PROTECT ROLLS

Rulli salivari

*Cotton rolls*



<b>00700037</b>	Protect Rolls - Size 1
<b>00700038</b>	Protect Rolls - Size 2
<b>00700039</b>	Protect Rolls - Size 3

## DESCRIPTION

Protect Rolls sono rulli salivari monouso non sterili, realizzati in puro cotone 100% che garantisce un'elevata assorbenza e resistenza ai liquidi. La loro particolare consistenza li rende ideali per impieghi prolungati

*Protect Rolls are disposable, non-sterile salivary rolls, made of 100% pure cotton that guarantees high absorbency and resistance to liquids. Their particular consistency makes them ideal for prolonged use*

## PACKAGING

- 1-2-3 size / 300 g

# PROTECT ASPIRE

Aspirasaliva monouso

*Disposable saliva ejectors*



## Available colours



## 15 cm - Removable caps

<b>00700081</b>	Protect Aspire - 15 cm - Clear
<b>00700082</b>	Protect Aspire - 15 cm - Light Blue
<b>00700083</b>	Protect Aspire - 15 cm - Green
<b>00700084</b>	Protect Aspire - 15 cm - Orange
<b>00700087</b>	Protect Aspire - 15 cm - Lilac

## DESCRIPTION

Protect Aspire sono aspirasaliva monouso in PVC atossico senza ftalati. Il filo metallico, in associazione alla speciale forma del cappuccio, assicurano un'aspirazione impeccabile evitando possibili danni alle mucose

*Protect Aspire are disposable saliva ejectors, made of atoxic and phthalates-free PVC. The metal thread and the special shape of the cup assure an impeccable aspiration avoiding possible damages to the mucous membranes*

## PACKAGING

- Confezione / Packaging: 100 pcs
- Box: 50 confezioni/ packages

# PROTECT CARPET

Tappeto decontaminante

*Decontaminating carpet*



<b>00700057</b>	Protect Carpet - 115x45 cm
<b>00700058</b>	Protect Aspire - 115x60 cm

## DESCRIPTION

Protect carpet, tappeto decontaminante batteriostatico è ideale per garantire la massima sterilità e pulizia negli ambienti odontoiatrici, conferendo l'idea di un ambiente asettico

*Protect carpet is a bacteriostatic decontaminating carpet, perfect to assure maximum sterility and cleanliness in dental environments, giving the idea of an aseptic location*

## PACKAGING

- Misura / Size
  1. 115 x 45 cm
  2. 115 x 60 cm
- Confezione: 5 tappeti - 30 fogli  
Packaging: 5 carpets - 30 sheets

# DABLIU PROTECTOR

Pellicola protettiva

*Barrier film*



00100120	Dabliu Protector - Blue
00100121	Dabliu Protector - Clear
00100122	Dabliu Protector - Green

## DESCRIPTION

Dabliu Protector è la pellicola adesiva monouso pretagliata, realizzata in polietilene, utile per la protezione di apparecchiature e strumentazione. Evita la contaminazione crociata e protegge le superfici del riunito da prodotti aggressivi e soluzioni disinfettanti.

*Dabliu Protector is a pre-cut disposable adhesive film, made of polyethylene, useful for protecting equipment and instruments. It prevents cross-contamination and protects dental unit surfaces from aggressive products and disinfectant solutions.*

## CHARACTERISTICS

- Realizzata in polietilene  
*Made of polyethylene*
- Spessore di 45 µm  
*Thickness of 45 µm*
- Ogni strappo ha una lunghezza di 15 cm  
*Each tear has a length of 15 cm*
- Larghezza di 10 cm  
*Width of 10 cm*
- Facile da utilizzare  
*Easy to use*

## ADVANTAGES

- Alta qualità: polietilene sicuro, leggero e igienico  
*High quality: safe, lightweight and hygienic polyethylene*
- Facilmente applicabile e rimovibile  
*Easily applicable and removable*
- Evita la contaminazione crociata  
*Avoids cross-contamination*
- Protegge le superfici da prodotti aggressivi  
*Protects surfaces from aggressive products*

## PACKAGING

1.200 strappi/ 1 rotolo con dispenser  
*1.200 tears/ 1 roll with dispenser*

# GUAINE PROTETTIVE *Bio*

## Guaine per manipoli

### Handpiece sleeves



#### DESCRIPTION

Guaina monouso per manipoli, ablatori e siringhe aria / acqua  
*Disposable sleeve for handpieces, scalars and air / water syringes.*

#### PACKAGING

- Grande / *Large* (conica / *conical*)  
 L: 3,7 / 1,8 cm x H: 23 cm - 500 pcs
- Piccola / *Small* (conica / *conical*)  
 L: 2,5 / 1,8 cm x H: 23 cm - 500 pcs

00480020	Large handpiece sleeves
00480021	Small handpiece sleeves

## Guaine per tubi d'aspirazione

### Suction tubes sleeves



#### DESCRIPTION

Guaina pretagliata per tubi d'aspirazione  
*Pre-cutted suction tube sleeves*

#### PACKAGING

L: 38 x H: 6/1,8 cm - (conica / *conical*) - 500 pcs

00480013	Suction tube sleeves
----------	----------------------

## Guaine per siringhe

### Syringes sleeves



#### DESCRIPTION

Guaina per siringa aria / acqua o aspirazione  
*Air / Water or aspiration syringe sleeve.*

#### PACKAGING

L: 26 x H: 6,3 cm - 500 pcs

00480018	Syringe sleeves
----------	-----------------

# GUAINA PROTETTIVA *Bio*

## Guaine per lampade a penna

### *Pen type curing light sleeves*



#### DESCRIPTION

Guaina per lampade fotopolimerizzanti a penna  
*Pen type curing light sleeve*

#### PACKAGING

L: 32 x H: 6,5/1,8 cm - (conica / *conical*) - 500 pcs

00480015 Pen type curing light sleeves

## Guaine videocamera

### *Intraoral camera sleeves*

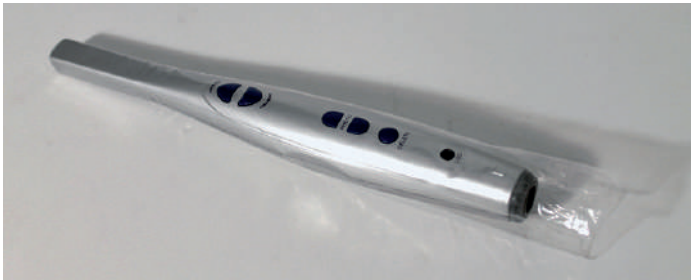

#### DESCRIPTION

Guaina in PVC, realizzata in morbido materiale plastico, ideale per videocamere intraorali  
*PVC sleeve, made of soft plastic material, ideal for intraoral cameras*

#### PACKAGING

L: 32 x H: 5/2,5 cm - (conica / *conical*) - 500 pcs

00480016 Intraoral camera sleeves

## Guaine per lampade alogene

### *Halogen curing light sleeves*



#### DESCRIPTION

Guaine per lampade fotopolimerizzanti alogene  
*Halogen curing light sleeves*

#### PACKAGING

L: 26 x H: 6,3 cm - 500 pcs

00480017 Halogen curing light sleeves

# GUAINE PROTETTIVE *Bio*

## Guaine per sensori

### *X-Ray sensor sleeves*



00480010 RVG sensor sleeves

#### DESCRIPTION

Guaina per sensori RVG. Non influisce sulla radiografia  
*RVG sensor sleeve. Doesn't affect the radiography*

#### PACKAGING

L: 22 x H: 3,8/5,8 cm - (conica / *conical*) - 500 pcs

## Guaine per specchietti e sensori

### *Mouth mirrors and X-Ray sensor sleeves*

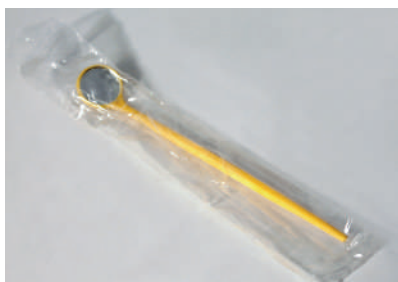

00480011 RVG sensor sleeves / mouth mirrors

#### DESCRIPTION

Guaina per sensori RVG e specchietti. Non influisce sulla radiografia  
*Mouth mirrors and RVG sensor sleeve. Doesn't affect the radiography*

#### PACKAGING

L: 20 x H: 4,2 cm - 500 pcs

## Guaine per radiografico

### *X-Ray sleeves*



00480012 X-Ray sleeve

#### DESCRIPTION

Copertura universale per radiografico. Non influisce sulla radiografia  
*Universal cover for radiograph. Doesn't affect the radiography*

#### PACKAGING

W: 36 cm x L:76 cm x H: 22 cm - 250 pcs

# GUAINE PROTETTIVE *Bio*

## Guaine per impugnature a "T"

### "T" style light handle sleeves



00480014 "T" Style light handle sleeves

#### DESCRIPTION

Guaina ideale per le impugnature a "T" delle lampade da riunito  
*Protective sleeve for all "T" type light handles of dental chairs*

#### PACKAGING

L: 3 x H1: 15 x H2: 9 cm - 500 pcs

## Guaine Bite Block

### Bite Block sleeves



00480009 Bite block cover

#### DESCRIPTION

Guaine per morso OPT, Bite block  
*Bite block protective sleeves*

#### PACKAGING

L: 5,1 x H: 2,1 cm - 1.000 pcs

## Tasche protettive per RX

### RX protective pouches



00480025	Pouches for RX - 188-0
00480026	Pouches for RX - 188-1
00480027	Pouches for RX - 188-2
00480028	Pouches for RX - 188-3
00480029	Pouches for RX - 188-4

#### DESCRIPTION

Tasche protettive per RX, apertura pretagliata, anche per sensori ai fosfori  
*RX sleeves with pre-cutted opening, also for phosphoric sensors*

#### PACKAGING

**188-0** L:3,8 x H: 2,5 cm - 100 pcs    **188-3** L:5,7 x H: 3,0 cm - 50 pcs  
**188-1** L:4,4 x H: 2,6 cm - 100 pcs    **188-4** L:8,2 x H: 5,8 cm - 50 pcs  
**188-2** L:4,4 x H: 3,5 cm - 100 pcs



# DABLIU BRUSH

Micro applicatori monouso

*Disposable micro applicators*

## Dabliu Brush

1.



Regular



Fine



Superfine

2.

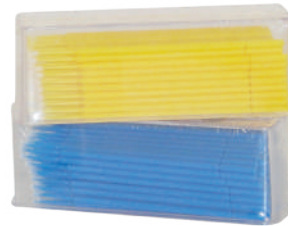

3.



## Dabliu Ultra Brush



## Dabliu Endo Brush



### DESCRIPTION

Dabliu Brush sono micro applicatori monouso realizzati in fibre non assorbenti, dotati di terminale orientabile

*Dabliu Brush are disposable micro applicators, realized with non-absorbent fibers and equipped with adjustable terminal*

### PACKAGING

#### Dabliu Brush

- Regular - Fine - Superfine
- 4x100 pcs

#### Dabliu Ultra Brush

- Long
- 100 pcs

#### Dabliu Endo Brush

- 100 pcs

### Dabliu Brush

1.

00100101	Dabliu Brush - Regular - Round tube
00100102	Dabliu Brush - Fine - Round tube
00100103	Dabliu Brush - Superfine - Round tube

2.

00100105	Dabliu Brush - Regular - Square tube
00100106	Dabliu Brush - Fine - Square tube
00100107	Dabliu Brush - Superfine - Square tube

3.

00100108	Dispenser for square tube
----------	---------------------------

### Dabliu Ultra Brush

00100109	Dabliu Ultra Brush
----------	--------------------

### Dabliu Endo Brush

00100110	Dabliu Endo Brush
----------	-------------------



# PENNELLINI MONOUSO

*Disposable brushes*

## Setola / Bristles

1.  Fine
2.  X-Fine

## Nylon

3.  Fine
4.  X-Fine

## Bristles

1.	<b>007012</b>	Disposable brush - Bristles - Fine - Black
2.	<b>007413</b>	Disposable brush - Bristles - X-Fine - Black

## Nylon

3.	<b>00340116</b>	Disposable brush - Nylon - Fine - White
4.	<b>007172</b>	Disposable brush - Nylon - X-Fine - White

### DESCRIPTION

Pennellini monouso in setola e nylon per adesivi, liquidi, medicinali e vernici

*Bristles and nylon disposable brushes, recommended for the application of adhesive, liquids, drugs and varnishes*

### PACKAGING

- Setola / Bristles: Fine - X-Fine - 100 pcs
- Nylon: Fine - X-Fine - 100 pcs

# APPLICATORI CON MANICO

*Micro applicator tips with handle*



<b>00100111</b>	Application tips
<b>0034117</b>	Handle

### DESCRIPTION

Micro applicatori con manico e terminale in microfibra

*Micro applicator tips provided with handle and terminal in microfiber material*

### PACKAGING

- Applicatori / Applicator tips: 100 pcs
- Manico / Handle: 1 pc

# ORTHO BOX

Contenitori per apparecchi ortodontici

Containers for orthodontic appliances

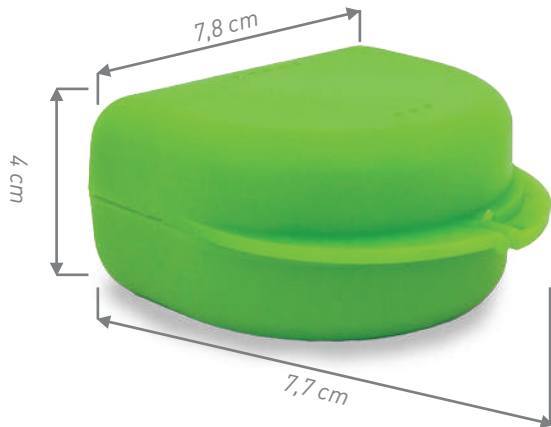

## DESCRIPTION

Gli Ortho Box sono contenitori indicati per la custodia ed il trasporto di apparecchi funzionali

*Ortho Box are containers recommended for the safe keeping and the transport of functional devices*

## CHARACTERISTICS

- Sono realizzati in plastica atossica di tipo alimentare, priva di lattice e ftalati  
*They are made of non-toxic and food-grade plastic, latex and phthalates free*
- Altezza di 40 mm  
*40 mm height*
- Superficie satinata  
*Frosted surface*

## ADVANTAGES

- Pratici e resistenti  
*Practical and resistant*
- Disinfettabili con soluzione a freddo  
*Disinfectable with cold solution*

## PACKAGING

Bag of 10 pcs

00340199	Ortho Box - Orange
00340201	Ortho Box - White
00340202	Ortho Box - Green
00340203	Ortho Box - Yellow Neon
00340204	Ortho Box - Fuxia Neon
00340205	Ortho Box - Red
00340206	Ortho Box - Blue
00340207	Ortho Box - Light Blue
00340208	Ortho Box - Silver
00340210	Ortho Box - Violet
00340211	Ortho Box - Fuxia
00340212	Ortho Box - Orange Neon
00340213	Ortho Box - Green Neon
00340215	Ortho Box - Yellow
00340216	Ortho Box - Ice
00340217	Ortho Box - Black

# ORTHO BITE

Contenitori per apparecchi ortodontici

Containers for orthodontic appliances

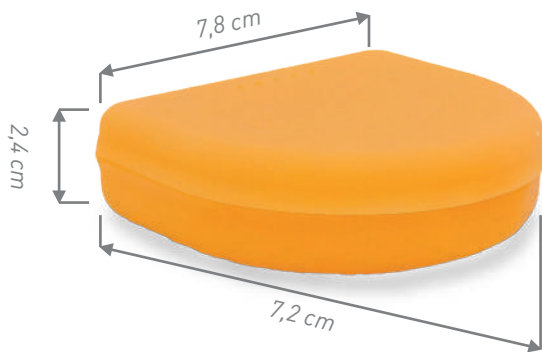

## DESCRIPTION

Gli Ortho Bite sono contenitori indicati per la custodia ed il trasporto di placche ortodontiche e bite

*Ortho Bite are containers recommended for the safe keeping and the transport of orthodontic appliances and bites*

## CHARACTERISTICS

- Sono realizzati in plastica atossica di tipo alimentare, priva di lattice e ftalati  
*They are made of non-toxic and food-grade plastic, latex and phthalates free*
- Altezza di 24 mm  
*24 mm height*
- Superficie satinata  
*Frosted surface*

## ADVANTAGES

- Pratici e resistenti  
*Practical and resistant*
- Disinfettabili con soluzione a freddo  
*Disinfectable with cold solution*

## PACKAGING

Bag of 10 pcs

00340227-N	Ortho Bite - Orange
00340228-N	Ortho Bite - Fuxia Neon
00340229-N	Ortho Bite - Light Blue
00340230-N	Ortho Bite - White
00340231-N	Ortho Bite - Green
00340232-N	Ortho Bite - Fuxia
00340233-N	Ortho Bite - Yellow Neon
00340234-N	Ortho Bite - Violet
00340235-N	Ortho Bite - Blue
00340236-N	Ortho Bite - Red
00340237-N	Ortho Bite - Yellow
00340238-N	Ortho Bite - Assorted
00340239-N	Ortho Bite - Black
00340240-N	Ortho Bite - Grey
00340241-N	Ortho Bite - Green Neon
00340242-N	Ortho Bite - Green Apple
00340243-N	Ortho Bite - Orange Neon

# PORTA PROTESI

Contenitori per la disinfezione di protesi e apparecchi

*Containers for the disinfection of prosthetics and orthodontic devices*

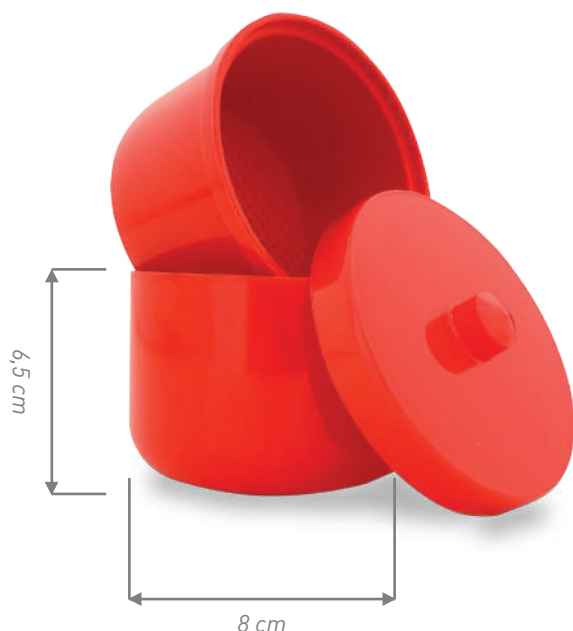

## DESCRIPTION

Contenitore porta protesi per la disinfezione a freddo di protesi, apparecchi funzionali e ortodontici

*Prosthesis cases for the cold disinfection of prosthesis; functional and orthodontic devices*

## CHARACTERISTICS

- Sono realizzati in plastica atossica di tipo alimentare, priva di lattice e ftalati  
*They are made of non-toxic and food-grade plastic, latex and phthalates free*
- Dotati di filtro per impurità  
*Provided with an impurity filter*

## ADVANTAGES

- Pratici e resistenti  
*Practical and resistant*
- Disinfettabili con soluzione a freddo  
*Disinfectable with cold solution*

## PACKAGING

1 pc

<b>00771460</b>	Prosthesis case - Violet
<b>00771464</b>	Prosthesis case - Green
<b>00771466</b>	Prosthesis case - White
<b>00771467</b>	Prosthesis case - Light Blue
<b>00771468</b>	Prosthesis case - Orange
<b>00771471</b>	Prosthesis case - Fuxia
<b>00771472</b>	Prosthesis case - Yellow
<b>00771472FN</b>	Prosthesis case - Fuxia Neon
<b>00771473</b>	Prosthesis case - Blue
<b>00771474</b>	Prosthesis case - Red
<b>00771475</b>	Prosthesis case - Green Apple

# ZOCCOLATORI

Basi per modello da studio ed archivio

*Study model bases*

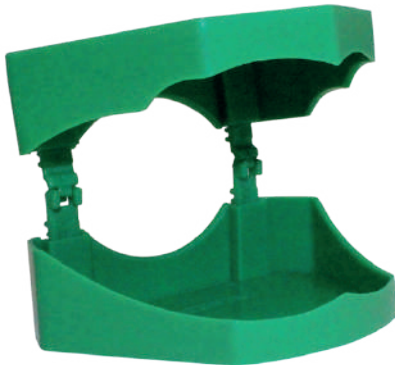

## Available colours

1  2  3  4

<b>3P1010</b>	Study model bases - White
<b>3P1011</b>	Study model bases - Fuxia
<b>3P1012</b>	Study model bases - Red
<b>3P1013</b>	Study model bases - Green

## DESCRIPTION

Zoccolatori monouso per modelli antagonisti in plastica

*Disposable plastic study model bases*

## CHARACTERISTICS

- Sono realizzati in plastica atossica di tipo alimentare, priva di lattice e ftalati  
*They are made of non-toxic and food-grade plastic, latex and phthalates free*
- Scomponibili  
*Modular*

## ADVANTAGES

- Pratici e resistenti  
*Practical and resistant*
- Disinfettabili con soluzione a freddo  
*Disinfectable with cold solution*

## PACKAGING

10 pcs

# DISPENSER PER RULLI

*Cotton rolls dispenser*



## Available colours

1  2  3  4

<b>00110012</b>	Dispenser - White
<b>00110017</b>	Dispenser - Blue
<b>00110018</b>	Dispenser - Red
<b>00110019</b>	Dispenser - Yellow

## DESCRIPTION

Dispenser per rulli salivari, dotato di un meccanismo che consente, con una leggera pressione sulla parte superiore, la fuoriuscita di un rullo per volta

*Cotton rolls dispenser, equipped with a mechanism that allows, with a slight pressure on the upper part, the release of one roller at a time*

## PACKAGING

1 pc

# VISIERE GALAXY E GALAXY DPI

Visiera protettiva - DM & DPI

Protective face shield - MD & PPE



## Available colours

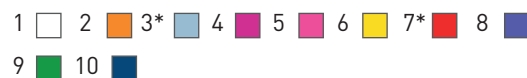

\* Disponibile solo per il modello non DPI.

\* Only available for the non PPE model.

## Regolazione misura / Size adjustment



## Protezione totale / Total protection



## DESCRIPTION

Visiera protettiva contro goccioline, spruzzi di liquidi e particelle proiettate. Realizzata in materiale plastico, leggera, facile da assemblare e dotata di fascia girotesta. Lo schermo può essere disinfettabile, ha una perfetta visibilità

*Protective visor against droplets, splashing liquids and projected particles. Made of plastic material, lightweight, easy to assemble and equipped with headband. The screen can be disinfected, has perfect visibility*

## PACKAGING

### Visiera Galaxy

#### Kit

- Visor x 1 pc
- Protective shields x 2 pcs
- Upper shield x 1 pc
- Shield stoppers x 5 pcs

#### Refill

- Protective shields x 3 pcs

### Visiera Galaxy DPI

#### Kit

- Visor x 1 pc
- Protective shield x 1 pc
- Upper shield x 1 pc
- Shield stoppers x 4 pcs

#### Refill

- Protective shields x 2 pcs

## Galaxy visor

<b>3P1021</b>	Refill Galaxy visor
<b>3P1011</b>	Galaxy visor - White
<b>3P10112A</b>	Galaxy visor - Orange
<b>3P1011C</b>	Galaxy visor - Light Blue
<b>3P1011F</b>	Galaxy visor - Fuxia
<b>3P1011FN</b>	Galaxy visor - Fuxia Neon
<b>3P1011G</b>	Galaxy visor - Yellow
<b>3P1011R</b>	Galaxy visor - Red
<b>3P1011V</b>	Galaxy visor - Violet
<b>3P1012</b>	Galaxy visor - Green
<b>3P1013</b>	Galaxy visor - Blue

## Galaxy PPE visor

<b>DPI-3P1000</b>	Refill Galaxy PPE visor
<b>DPI-3P1011</b>	Galaxy PPE visor - White
<b>DPI-3P1012</b>	Galaxy PPE visor - Green
<b>DPI-3P1013</b>	Galaxy PPE visor - Blue
<b>DPI-3P1014</b>	Galaxy PPE visor - Fuxia
<b>DPI-3P1015</b>	Galaxy PPE visor - Yellow
<b>DPI-3P1016</b>	Galaxy PPE visor - Violet
<b>DPI-3P1017</b>	Galaxy PPE visor - Fuxia Neon
<b>DPI-3P1018</b>	Galaxy PPE visor - Orange

# VISIERE VISION E VISION DPI

Visiera protettiva - DM & DPI

Protective face shield - MD & PPE



## Available colours

1  2  3  4  5   
6  7  8  9  10

## DESCRIPTION

Visiera protettiva contro goccioline, spruzzi di liquidi e particelle proiettate. Realizzata in materiale plastico, leggera, facile da assemblare e dotata di fascia girotesta. Lo schermo può essere disinfettabile, ha una perfetta visibilità

*Protective visor against droplets, splashing liquids and projected particles. Made of plastic material, lightweight, easy to assemble and equipped with headband. The screen can be disinfected, has perfect visibility.*

## PACKAGING

### Vision visor

#### Kit

- Visor x 1 pc
- Protective shield x 1 pc
- Shield stoppers x 7 pcs

#### Refill

- Protective shields x 2 pcs

### Vision PPE visor

#### Kit

- Visor x 1 pc
- Protective shield x 1 pc
- Shield stoppers x 7 pcs

#### Refill

- Protective shields x 2 pcs

### Vision visor

<b>4P1000</b>	Vision visor refill
<b>4P1011</b>	Vision visor - White
<b>4P1012</b>	Vision visor - Green
<b>4P1013</b>	Vision visor - Blue
<b>4P1014</b>	Vision visor - Fuxia
<b>4P1015</b>	Vision visor - Yellow
<b>4P1016</b>	Vision visor - Violet
<b>4P1017</b>	Vision visor - Fuxia Neon
<b>4P1018</b>	Vision visor - Orange
<b>4P1019</b>	Vision visor - Light blue
<b>4P1020</b>	Vision visor - Red

### Vision PPE visor

<b>DPI-4P1000</b>	Vision PPE visor refill
<b>DPI-4P1011</b>	Vision PPE visor - White
<b>DPI-4P1012</b>	Vision PPE visor - Green
<b>DPI-4P1013</b>	Vision PPE visor - Blue
<b>DPI-4P1014</b>	Vision PPE visor - Fuxia
<b>DPI-4P1015</b>	Vision PPE visor - Yellow
<b>DPI-4P1016</b>	Vision PPE visor - Violet
<b>DPI-4P1017</b>	Vision PPE visor - Fuxia Neon
<b>DPI-4P1018</b>	Vision PPE visor - Orange
<b>DPI-4P1019</b>	Vision PPE visor - Light blue
<b>DPI-4P1020</b>	Vision PPE visor - Red



# PROTECTIVE GLASS

Occhiali protettivi

*Protective goggles*



**Trasparenti - DM & DPI**  
*Transparent - MD & PPE*



**Arancioni / Orange**

## INDICATIONS

- **Trasparenti:** per protezione da getti di spray e fluidi  
*Transparent: to protect from droplets, spray and liquids*
- **Arancio:** per protezione da radiazioni emesse da luce blu  
*Orange: to protect from blue light radiations*

## CHARACTERISTICS

- Struttura in policarbonato  
*Polycarbonate structure*
- Antigraffio / Anti-appannamento  
*Scratch proof / Anti-fog*
- Sovrapponibile ai normali occhiali da vista  
*Stackable on top of regular eyeglasses*

## PACKAGING

1 pc

<b>00400012</b>	Protective Glass - Orange
<b>00400018</b>	Protective Glass - Transparent - MD
<b>00400018-DPI</b>	Protective Glass - Transparent - PPE

# DABLIU BITE OPENER



**Large**

**Medium**

**Small**

## DESCRIPTION

Set di apribocca (Piccolo - Medio - Grande) per apertura del morso  
*Set (Small - Medium - Large) for bite opening*

## ADVANTAGES

Autoclavabile a 121°C  
*Autoclavable at 121°C*

## PACKAGING

- Kit**
- 3 pcs (Small - Medium - Large)
- Refill**
- 1 pc

<b>00340260</b>	Dabliu Bite Opener - Kit
<b>00340260S</b>	Dabliu Bite Opener - Small
<b>00340260M</b>	Dabliu Bite Opener - Medium
<b>00340260L</b>	Dabliu Bite Opener - Large

# TAZZINE PER RESINA

*Cups for resin*



00340270	Silicone mixing cups - 5 ml - Ø 2,5
00340271	Silicone mixing cups - 7 ml - Ø 3
00340272	Silicone mixing cups - 10 ml - Ø 3,5
00340273	Silicone mixing cups - 25 ml - Ø 4,5
00340274	Silicone mixing cups - 75 ml - Ø 6,5
00340275	Silicone mixing cups - Kit

## DESCRIPTION

Tazzine per resina in silicone dotate di fondo con ventosa, disponibili in 5 differenti misure

*Silicone cups for resin provided with bottom with suction cup; available in 5 different sizes*

## ADVANTAGES

Utilizzate per la miscelazione della resina

*Used for mixing resin*

## SIZES

5 ml - 7 ml - 10 ml - 25 ml - 75 ml

## PACKAGING

- **Kit**  
5 pcs
- **Refill**  
1 pc

# ANELLI CODIFICATORI

*Coding rings*



00770189	Coding rings - Black
00770190	Coding rings - Green
00770191	Coding rings - White
00770192	Coding rings - Yellow
00770193	Coding rings - Light blue
00770194	Coding rings - Blue
00770196	Coding rings - Red
00770199	Coding rings - Assorted

## DESCRIPTION

Anelli codificatori realizzati in silicone permettono di identificare ogni tipologia di strumento in base alla colorazione

*Silicone coding rings which allow to identify each type of instrument based on color*

## ADVANTAGES

Autoclavabile a 121°C

*Autoclavable at 121°C*

## PACKAGING

Box 50 pcs

# ENCODER TAPE

*Coding tape*



00700181	Encoder Tape - White
00700182	Encoder Tape - Blue
00700183	Encoder Tape - Green
00700184	Encoder Tape - Orange
00700185	Encoder Tape - Yellow
00700186	Encoder Tape - Red
00700187	Encoder Tape - Brown
00700188	Encoder Tape - Black
00700189	Encoder Tape - Purple

## DESCRIPTION

Nastro codificatore realizzato in materiale autoclavabile che permette di identificare ogni tipologia di strumento in base alla colorazione

*Coding tape made of autoclavable material that allows the identification of every type of instrument by color*

## SIZE

W: 7 mm; L: 5,1 m

## PACKAGING

1 pc

# CRISTAL TOOTH

**Gioiello dentale**

*Dental jewel*



07001	Cristal Tooth - Mixed
07004	Cristal Tooth - Cristal
07005	Cristal Tooth - Iris
07006	Cristal Tooth - Gold
07007	Cristal Tooth - Light Blue
07008	Cristal Tooth - Green
07009	Cristal Tooth - Red
07010	Cristal Tooth - Black
07011	Cristal Tooth - Violet
07012	Cristal Tooth - Pink

## DESCRIPTION

Gioiello dentale in cristallo, disponibile in nove colori, dotato di basetta per ritenzione meccanica

*Crystal dental jewel, available in nine colors, with base for mechanical retention*

## CHARACTERISTICS

Diametro/ *Diameter*: Ø 1,8 mm

## PACKAGING

Box 10 pcs

# DABLIU APRIBOCCA

Divaricatore labiale e guanciaie

*Lip and cheek retractor*

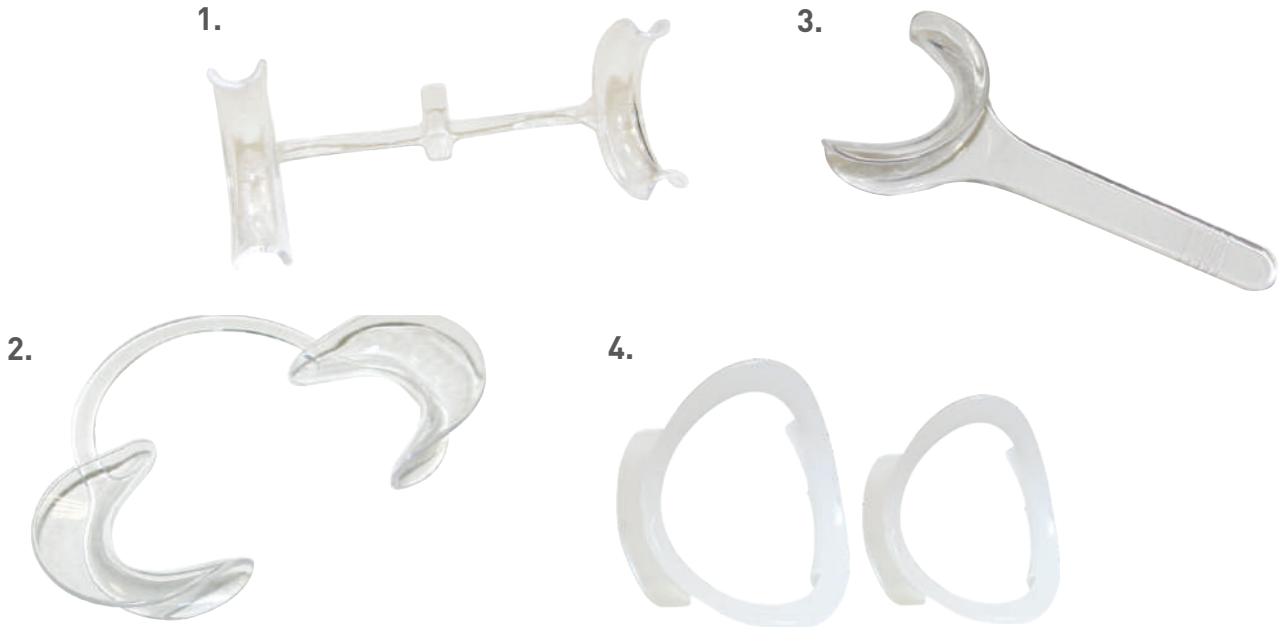

## DESCRIPTION

Dabliu Apribocca in policarbonato con o senza contenzione linguale, per una maggiore visione della cavità orale.

*Dabliu cheek retractor in polycarbonate with or without lingual dental splinting, for a better complete vision of the oral cavity.*

## CHARACTERISTICS

1. **Apribocca con fermalingua**  
Medio - Largo / Trasparente - Blu  
*Cheek retractor with tongue guard*  
*Medium - Large / Clear-blue*
2. **Divaricatore labiale**  
Adulto - Bambino  
*Lip retractor*  
*Adult - Child*
3. **Divaricatore labiale monolaterale**  
*Unilateral lip retractor*
4. **Apribocca verticale**  
Adulto - Bambino  
*Vertical cheek retractor*  
*Adult - Child*

## ADVANTAGES

Autoclavabile a 121°C.  
*Autoclavable at 121°C.*

## PACKAGING

1. 2 pcs / 10 pcs.
2. 2 pcs.
3. 2 pcs.
4. 10 pcs.

1.

00340261	Cheek retractor with tongue guard - Clear - Medium - 2 pcs
00340262	Cheek retractor with tongue guard - Clear - Large - 2 pcs

2.

00340266	Lip retractor - Adult - 2 pcs
00340267	Lip retractor - Child - 2 pcs

3.

00340268	Unilateral lip retractor - 2 pcs
----------	----------------------------------

4.

00340257	Vertical cheek retractor - Adult - 10 pcs
00340265	Vertical cheek retractor - Child - 10 pcs

# RX POSITIONERS

Sistemi di centratura per radiografie con sensori, lastre ai fosfori e pellicole

*Positioning systems for radiographs with sensors, phosphor plates and films*

## DESCRIPTION

I sistemi di posizionamento autoclavabili "RX Positioner", "RX Positioner Multi" e "RVG Positioner" sono utilizzati in odontoiatria per migliorare la precisione e la rapidità nella produzione di immagini a raggi-X

*The "RX Positioner," "RX Positioner Multi," and "RVG Positioner" autoclavable positioning systems are used in dentistry to improve accuracy and speed in the production of x-ray images*

### RX Positioner Multi - Film & Phosphor plates



#### 1. RX Positioner Multi - Film & Phosphor plates

- Blu: Anteriori - 3 pz  
*Blue: Anteriors - 3 pcs*
- Arancione: Mascellare sinistro e mandibolare destro - 3 pz  
*Orange: Maxillary left and mandibular right - 3 pcs*
- Giallo: Mandibolare sinistro e mascellare destro - 3 pz  
*Yellow: Mandibular left and maxillary right - 3 pcs*
- Rosso: Bitewings - 1 pz  
*Red: Bitewings - 1 pc*

00520039 RX Positioner Multi - Film & Phospor Plates

### RVG Positioner



#### 2. RVG Positioner

- Verde: premolare/molare superiore mascellare destro e mandibolare sinistro - 1 pz  
*Green: maxillary right upper premolar/molar and mandibular left - 1 pc*
- Blu: premolare mascellare sinistro e premolare/molare mandibolare destro - 1 pz  
*Blue: left maxillary premolar and right mandibular premolar/molar - 1 pc*
- Giallo: incisivo mascellare/mandibolare denti anteriori - 1 pz  
*Yellow: maxillary incisor/mandibular anterior teeth - 1 pc*

00520040 RVG Positioner

### RX Positioner - Film



#### 3. RX Positioner - Film

- Blu: Anteriori - 4 pz  
*Blue: Anteriors - 4 pcs*
- Giallo: Posteriori - 8 pz  
*Yellow: Posteriors - 8 pcs*
- Rosso: Bitewings - 5 pz  
*Red: Bitewings - 5 pcs*
- Verde: Endodontico - 2 pz  
*Green: Endodontic - 2 pcs*

00520041 RX Positioner - Film

# LUBRISPRAY

Olío lubrificante per manipoli

*Lubricant oil for handpieces*



00340180	Lubrispray
00340181	Universal spout

## DESCRIPTION

LubriSpray è un lubrificante sintetico sviluppato appositamente per la manutenzione di varie tipologie di strumenti come turbine, contrangoli, strumenti chirurgici, ablatori e micromotori ad aria. Grazie alla sua azione lubrificante e protettiva, prolunga la durata degli strumenti, riducendo usura e surriscaldamento. Da impiegare prima di autoclavare il dispositivo.

*LubriSpray is a synthetic lubricant specially developed for the maintenance of various types of instruments such as turbines, contra-angles, surgical instruments, scalers and air micromotors. Thanks to its lubricating and protective action, it extends the life of instruments, reducing wearing and overheating. Use before autoclaving the instrument.*

## CHARACTERISTICS

- Lubrificante ad alte prestazioni per manipoli odontoiatrici  
*High-performance lubricant for dental handpieces*
- Protegge dall'usura e dal surriscaldamento  
*Protection against wearing and overheating*
- Formula anti-corrosione contro residui biologici e agenti chimici  
*Anti-corrosion formula against biological residues and chemical agents*
- Resistente alla sterilizzazione  
*Resistant to sterilization*

## ADVANTAGES

- Lubrificazione eccellente  
*Excellent lubrication*
- Resistente alla sterilizzazione  
*Resistant to sterilization*
- Prolunga la vita dei manipoli  
*Extends the duration of the handpieces*
- Minimizza l'attrito e il surriscaldamento  
*Minimizes friction and overheating*
- Protezione completa contro corrosione e depositi di residui organici  
*Full protection against corrosion and organic residues build-up*
- Facile da usare  
*Easy to use*

## PACKAGING

- Bomboletta da 500 ml  
*500 ml bottle*
- Box contenente 12 bombolette da 500 ml cad.  
*Box containing 12 bottles of 500 ml each*

# EASYFORM EVOLUTION

**Termoformatrice automatica**

*Automatic thermoforming machine*



<b>00340720</b>	EasyForm Evolution
<b>001040</b>	Spheres - Ø 0,40 mm
<b>001041</b>	Spheres - Ø 0,28 mm

## DESCRIPTION

La Evolution è una termoformatrice con processo di termoformatura completamente automatico. Il processo viene assicurato mediante l'impostazione del tempo in funzione della tipologia del foglio utilizzato e del suo spessore

*Evolution is an automatic thermoforming machine. The automatic process is assured by setting the time according to the type of sheet used and its thickness*

## CHARACTERISTICS

- Display digitale  
*LCD display*
- Controllo a microprocessore SMD  
*SMD technology*
- Tempi impostabili (da 15" a 7')
- Setting times (from 15" to 7')*
- Resistenza 350 Watt  
*Resistance 350 Watt*
- Pompa del vuoto integrata con pistone  
*Vacuum pump with piston included*
- Pressione massima 250 mbar  
*Maximum pressure 250 mbar*
- Rumorosità 56 dB  
*Noise level 56 dB*

## ADVANTAGES

- Processo di termoformatura completamente automatico  
*Fully automatic thermoforming process*
- Possibilità di utilizzo dischi quadrati o tondi da 120 a 125 mm  
*Possibility of using square or round sheets from 120 to 125 mm*
- Non necessita di aria compressa o fonti esterne di aria per aspirazione  
*Compressed air or external sources of suction air not required*

## PACKAGING

- Termoformatrice: 1 pz  
*Thermoforming machine: 1pc*
- Cestello porta sfere: 1 pz  
*Spheres basket: 1 pc*
- Cestello di dettaglio: 1 pz  
*Detail basket: 1 pc*
- Cavo di alimentazione: 1 pz  
*Power cable: 1 pc*
- Libretto istruzioni  
*Instruction for use*

# EASYFORM ASPY

Termoformatrice manuale

*Manual thermoforming machine*



<b>00340080</b>	EasyForm Aspy
<b>001040</b>	Spheres - Ø 0,40 mm
<b>001041</b>	Spheres - Ø 0,28 mm

## DESCRIPTION

La Aspy è una termoformatrice manuale che consente all'operatore di gestire manualmente le fasi di termoformatura.

L'operatore aziona la resistenza mediante l'apposito pulsante ed una volta riscaldato il foglio termoformabile in maniera appropriata, può procedere azionando la pompa del vuoto

*Aspy is a manual thermoforming machine which allows the operator to manually manage the thermoforming steps. The operator activates the resistance by a specific button, and once the thermoforming sheet is appropriately heated, he can proceed by activating the vacuum pump*

## CHARACTERISTICS

- Resistenza 350 Watt  
*Resistance 350 Watt*
- Pompa del vuoto integrata con pistone  
*Vacuum pump with piston included*
- Pressione massima 250 mbar  
*Maximum pressure 250 mbar*
- Rumorosità 56 dB  
*Noise level 56 dB*

## ADVANTAGES

- Possibilità di utilizzo di dischi quadrati o tondi da 120 a 125 mm  
*Possibility of using square or round sheets from 120 to 125mm*
- Non necessita di aria compressa o fonti esterne di aria per aspirazione  
*Compressed air or external sources of suction air not required*

## PACKAGING

- Termoformatrice: 1 pz  
*Thermoforming machine : 1 pc*
- Cestello porta sfere: 1 pz  
*Spheres basket: 1 pc*
- Cestello di dettaglio: 1 pz  
*Detail basket: 1 pc*
- Cavo di alimentazione: 1 pz  
*Power cable: 1 pc*
- Libretto istruzioni  
*Instruction for use*



# ORTHO FORM

Placche termoformabili

*Thermoforming sheets*



REF 00XXXXR



Ø 120 mm

REF 00XXXXRB



Ø 134 mm

REF 00XXXXRS



Ø 125 mm

REF 00XXXX



125 x 125 mm

## DESCRIPTION

Ortho Form sono dischi termoplastici rigidi e morbidi, per qualsiasi tipo di lavorazione come mascherine per sbiancamento, bite per bruxismo, applicazioni per ATM, mascherine di contenzione, etc. Disponibile nelle misure: 125 x 125 mm, Ø 120 mm, Ø 125 mm, Ø 134 mm

*Ortho Form hard and soft thermoforming sheets, recommended for any kind of working, such as bleaching masks, bite for bruxism, ATM applications, contention masks etc. Available in: 125 x 125 mm, Ø 120 mm, Ø 125 mm, Ø 134 mm*

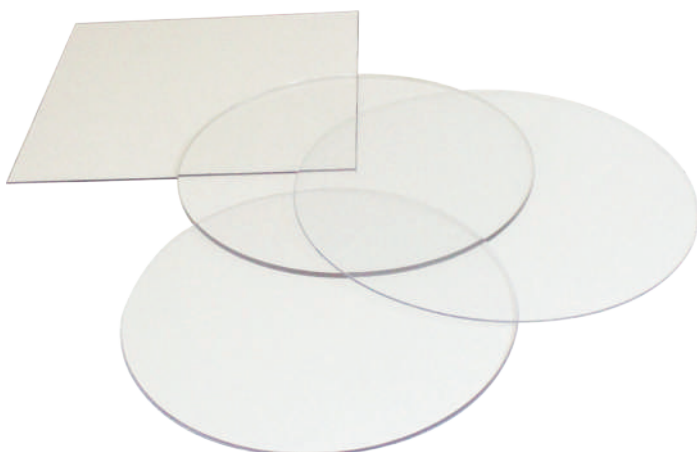

## INDICATIONS

- Per i modelli si consiglia l'utilizzo di un gesso di III classe  
*The use of a 3rd class gypsum is recommended for models*
- Evitare l'utilizzo di gessi troppo duri (causerebbero la rottura del modello in fase di distacco)  
*The use of excessively hard gypsums is not recommended (they may cause the break of the model during the separation step)*
- Per ottenere un buon dettaglio il gesso deve avere un'ottima permeabilità all'aria  
*To obtain a great detail, the gypsum must have an excellent permeability to air*
- Il modello in gesso non dev'essere assolutamente bagnato, al massimo può essere umido  
*The gypsum model mustn't be absolutely wet, but at most only damp*
- In caso di modelli alti, si consiglia di ridurli con una squadramodelli, o immergerli in sfere di acciaio in modo da far fuoriuscire solo la parte da termoformare  
*In case of high models, it's better to make a reduction with a melting machine, or put them in steel spheres to facilitate the leak of the thermoforming section*
- Eliminare eventuali bolle causate dalla colatura del gesso  
*Remove possible bubbles caused by the trickle of the gypsum*
- Valutare le caratteristiche tecniche / fisiche dei fogli termoplastici prima dell'utilizzo  
*Evaluate the technical / physical features of the thermoforming sheets before their use*

## SOFT FORM

Etilenvinilacetato (EVA), indicato per mascherine di sbiancamento, patologie ATM, fluoro profilassi, docce morbide per Bruxismo.

*Eva material, recommended for bleaching masks, ATM pathologies, fluoride prophylaxis, Bruxism.*

	Pack	SQUARE	ROUND Ø120	ROUND Ø125	ROUND Ø134
1,0 mm	24 pcs	001817	001817R	001817RS	001817RB
1,5 mm	20 pcs	001835	001835R	001835RS	001835RB
2,0 mm	20 pcs	001836	001836R	001836RS	001836RB
3,0 mm	10 pcs	001837	001837R	001837RS	001837RB
4,0 mm	10 pcs	001838	001838R	001838RS	001838RB

## DURA FORM

Polietilene tereftalato, indicato per matrici provvisorie, docce dure per Bruxismo e sbiancamento, cucchiari chirurgici e applicazioni in ortodonzia.

*Polyethylene terephthalate recommended for temporary matrix, Bruxism and bleaching bites, surgical tray and orthodontic appliances.*

	Pack	SQUARE	ROUND Ø120	ROUND Ø125	ROUND Ø134
0,5 mm	24 pcs	001828	001828R	001828RS	001828RB
0,8 mm	24 pcs	001827	001827R	001827RS	001827RB
1,0 mm	24 pcs	001823	001823R	001823RS	001823RB
1,5 mm	20 pcs	001824	001824R	001824RS	001824RB
2,0 mm	15 pcs	001826	001826R	001826RS	001826RB
3,0 mm	10 pcs	001833	001833R	001833RS	001833RB

## DUAL FORM

Placca a due strati, strato duro SBS e strato morbido EVA. Consigliata per docce rigide per Bruxismo, patologie ATM ed applicazioni in ortodonzia.

*Plate with two layers, SBS hard layer and EVA soft layer. Suitable for Bruxism, ATM pathologies orthodontic appliances.*

	Pack	SQUARE	ROUND Ø120	ROUND Ø125	ROUND Ø134
2 mm	10 pcs	001943	001943R	-	-
3 mm	10 pcs	001939	001939R	-	-

## BASE PLATE FORM

Stirene ad alta compressione. Indicato per cucchiari per montaggi in protesi totale e supporti rinforzati per valli di cera (masticoni).

*High compression styrene. Recommended for trays and reinforced supports to fit complete dentures.*

	Pack	SQUARE	ROUND Ø120	ROUND Ø125	ROUND Ø134
1,5 mm	24 pcs	001819	001819R	-	-
2,0 mm	20 pcs	001818	001818R	-	-
2,5 mm	10 pcs	001820	001820R	-	-

## COPING FORM

Polipropilene opaco, indicato per ponti e corone provvisorie, cappette calcinabili.

*Opaque polypropylene suitable for temporary bridges and crowns, castable copings.*

	Pack	SQUARE	ROUND Ø120	ROUND Ø125	ROUND Ø134
0,5 mm	24 pcs	001830	001830R	-	-
0,8 mm	24 pcs	-	001831R	-	-
1,0 mm	24 pcs	001832	001832R	-	-

*Disponibili fino ad esaurimento scorte / Available until supplies last*

## TRAY FORM

Stirene ad alta compressione. Indicato per portaimpronte individuali.

*High compression styrene. Recommended for individual impression trays.*

	Pack	SQUARE	ROUND Ø120	ROUND Ø125	ROUND Ø134
3 mm	10 pcs	001822	001822R	-	-

# FISIO SURGERY

Motore per implantologia

*Implantology motor*



Irrigation tubing



Pedale DeLuxe



00390090	Fisio Surgery LED
00390093	Fisio Surgery DFT
00390094	Carrying case
00390096	Surgical irrigation tubing - 10 pcs

## DESCRIPTION

Fisio Surgery e Fisio Surgery LED sono unità per implantologia progettate in modo semplice, sicuro ed affidabile. La potenza del motore brushless dal design italiano, in associazione alla dualità del torque e della velocità, li rendono tra le migliori unità presenti sul mercato

*Fisio Surgery and Fisio Surgery LED are implantology units designed in a simple, safe and reliable way. The power of the brushless motor, marked by an Italian design, combined with the duality of torque and speed, make them some of the best units on the market*

## CHARACTERISTICS

- Velocità del motore da 400 a 40,000 Rpm  
*Speed motor from 400 to 40,000 Rpm*
- Valore del torque da 6 a 72 Ncm  
*Torque value from 6 to 72 Ncm*
- 3 differenti flussi di irrigazione: 100 ml / min.  
*3 different irrigation flows: 100 ml / min.*
- Rapporto di riduzione / *Reduction ratio:*  
1:1 - 16:1 - 20:1 - 24:1 - 32:1 - 64:1 - 80:1
- Motore brushless  
*Brushless motor*
- Pompa di irrigazione esterna monouso  
*Disposable external irrigation pump*

## ADVANTAGES

- 5 programmi memorizzabili  
*5 saving programs*
- Compensa automaticamente la perdita di torque dovuta al contrangolo  
*The loss of torque due to the contra-angle is automatically compensated*

## PACKAGING

- Console di controllo elettronica  
*Electronic control station*
- Micromotore con luce LED\*  
*LED Contrangle\**
- Pedale "DeLuxe"  
*"DeLuxe" pedal*
- Asta di sospensione per sacchi da irrigazione  
*Suspension rod for irrigation bag*
- Tubi per pompe peristaltiche  
*Hoses for peristaltic pumps*
- Alimentatore  
*Power supply*

\*Disponibile solo nella versione "LED"  
*\*Available only on the "LED" version*

# FISIO SURGERY TOUCH

Motore per implantologia touch-screen

*Touch-screen implantology motor*

Fisio Surgery Touch



Irrigation tubing



DeLuxe pedal



00390097	Fisio Surgery Touch
00390094	Carrying case
00390096	Surgical irrigation tubing - 10 pcs

## DESCRIPTION

Fisio Surgery Touch è un'unità per implantologia con schermo touch-screen progettata in modo semplice, sicuro ed affidabile. La potenza del motore brushless, in associazione alla dualità del torque e della velocità, lo rendono tra le migliori unità presenti sul mercato

*Fisio Surgery Touch is a touch-screen implantology unit designed in a simple, safe and reliable manner. The power of the brushless motor, in combination with the duality of torque and speed, make it among the best units on the market*

## CHARACTERISTICS

- Velocità del motore da 400 a 40,000 Rpm  
*Speed motor from 400 to 40,000 Rpm*
- Valore del torque da 6 a 72 Ncm  
*Torque value from 6 to 72 Ncm*
- 3 differenti flussi di irrigazione: 100 ml / min.  
*3 different irrigation flows: 100 ml / min.*
- Rapporto di riduzione / *Reduction ratio:*  
1:1 - 16:1 - 20:1 - 24:1 - 32:1 - 64:1 - 80:1
- Motore brushless  
*Brushless motor*
- Pompa di irrigazione esterna monouso  
*Disposable external irrigation pump*

## ADVANTAGES

- 5 programmi memorizzabili  
*5 saving programs*
- Compensa automaticamente la perdita di torque dovuta al contrangolo  
*The loss of torque due to the contra-angle is automatically compensated*

## PACKAGING

- Console di controllo elettronica  
*Electronic control station*
- Micromotore con luce LED  
*LED Contrangle*
- Pedale "DeLuxe"  
*"DeLuxe" pedal*
- Asta di sospensione per sacchi da irrigazione  
*Suspension rod for irrigation bag*
- Tubi per pompe peristaltiche  
*Hoses for peristaltic pumps*
- Alimentatore  
*Power supply*

# Linea CONSERVATIVA

DW DENTAL  
WORLD

Tecnologia nanofiller  
Adesione perfetta  
Lavorabilità eccellente

**CREAFILL  
NHC**  
COMPOSITO NANO-IBRIDO

Fondation Opaque	100
Margin Opaque	100
Dentine Opaque	100 100 100 100
Dentine	100 100 100 100 100 100 100 100 100 100
Translucent	100 100 100 100
Incisal	100 100 100 100
Opalescent	100 100



**ONE BUILD  
PLUS**

CEMENTO UNIVERSALE  
AUTOADESIVO

## CREAFILL REPAIR

SISTEMA DI RESTAURO PER  
SUPERFICI METALLICHE E  
CERAMICHE

Kit progettato per una soluzione completa  
e per ottenere i migliori risultati



Corone e ponti  
Inlay e onlay  
Faccette  
Ceramica e metallo  
Zirconia



Composito fotopolimerizzabile, micro-ibrido, nano-riempito, fluido

Composito fluido fotopolimerizzabile per caratterizzazioni

Diga liquida fotopolimerizzabile

Sistema di tonalità gengivali fotopolimerizzabili

Cemento temporaneo auto-miscelante senza eugenolo

Cemento a doppia polimerizzazione per otturazioni, ricostruzioni di monconi e parni

Mordenzante per ceramica - gel al 10% di acido fluoridrico

Agente mordenzante per smalto e dentina al 37% - senza silice

**Versatilità, affidabilità e completezza**



Dental World s.r.l. Via Antichi Pastifici, 15 - 70056 Molfetta (BA) ITALY  
tel. +39 080.338.10.04 / fax +39 080.338.66.17  
[www.dental-world.it](http://www.dental-world.it) / [info@dental-world.it](mailto:info@dental-world.it)

